

Liune Door

A sliding door element integrated in a partition wall



■ NEVER IN YOUR WAY!

LIUNE

CONTENT

Structural properties	3
Materials and equipment, storage	4
Sliding-door unit	4
Door leaf and frame components	4
Door mechanisms	4
Installation screws	4
Electrical accessories	4
Logistics	5
Support of the sliding-door unit	5
Time of delivery of the sliding-door unit	5
Moving the sliding-door unit on site	5
Installation instructions	6
Building the partition wall (Sections 1–3)	6
Installation of the LIUNE sliding-door unit (Sections 4–10)	8
Installation of the door leaf (Sections 11–14)	10
Installation of MDF frame cover strips and alignment of door (Sections 15–19)	11

PRODUCT SPECIFICATION 9/2013

The technical and other product data in this specification are for information purposes and are continually revised by Aulis Lundell Oy.

The data contained is current at the moment of printing. Aulis Lundell Oy reserves the right to alter the data / files referred to in this specification. The data in this specification replaces that in our previously updated brochures and other documents.

In possible cases of uncertainty, please contact us directly. Please also send us any suggestions you have for improvements and changes. Our contact details are



Liune concept gives you and your home usable space of 1-3 m² a door!

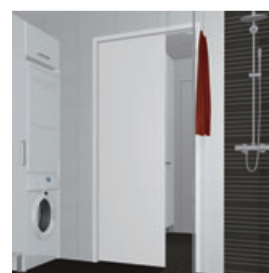

LIUNE STANDARD DOOR MODELS

- | | | |
|-------------------------------------|------------------------------|--|
| D3 Smooth white sliding door | D7 Light opening door | D11 Sauna door |
| D4 White milled mirror door | D8 Panel door | D13 Veneer doors |
| D5 Moisture-resistant door | D9 Glass door | D14 Print glass door |
| D6 Oak veneer door | D10 Mirror door | D15 Classic sliding door by Liune |

STRUCTURAL PROPERTIES

LIUNE is a sliding-door element installed in a partition wall, in which the door leaf slides into the wall. The frame of the sliding-wall element, which is part of the Lundell Profile wall frame, is installed in the wall structure once one side of the wall has been boarded. The Liune sliding-door unit is suitable for both new building and renovation in dwellings and offices.

LIUNE sliding-door units can be installed inside partition-wall systems of different thicknesses, the standard sizes being 66 mm, 70 mm, 95 mm, and 120 mm. The standard door-opening widths are LiO6-LiO12 and LiO12-LiO20. Liune can be installed in the frame of a steel, timber, or concrete partition.

The 66-mm LiO8 **Liune sliding-door** unit weighs 29 kg, total weight of a element and its package.

The weights of other sizes vary by +/-1kg /wall thickness.

There are several alternative door leaves.

The basic model is a white, smooth, 25 mm MDF door. Our standard collection offers a wide selection of options to get started. Special models are available to meet customer requirements, as are different materials and colours. If necessary, the door leaf can be always changed later for new design without touching the wall structure.

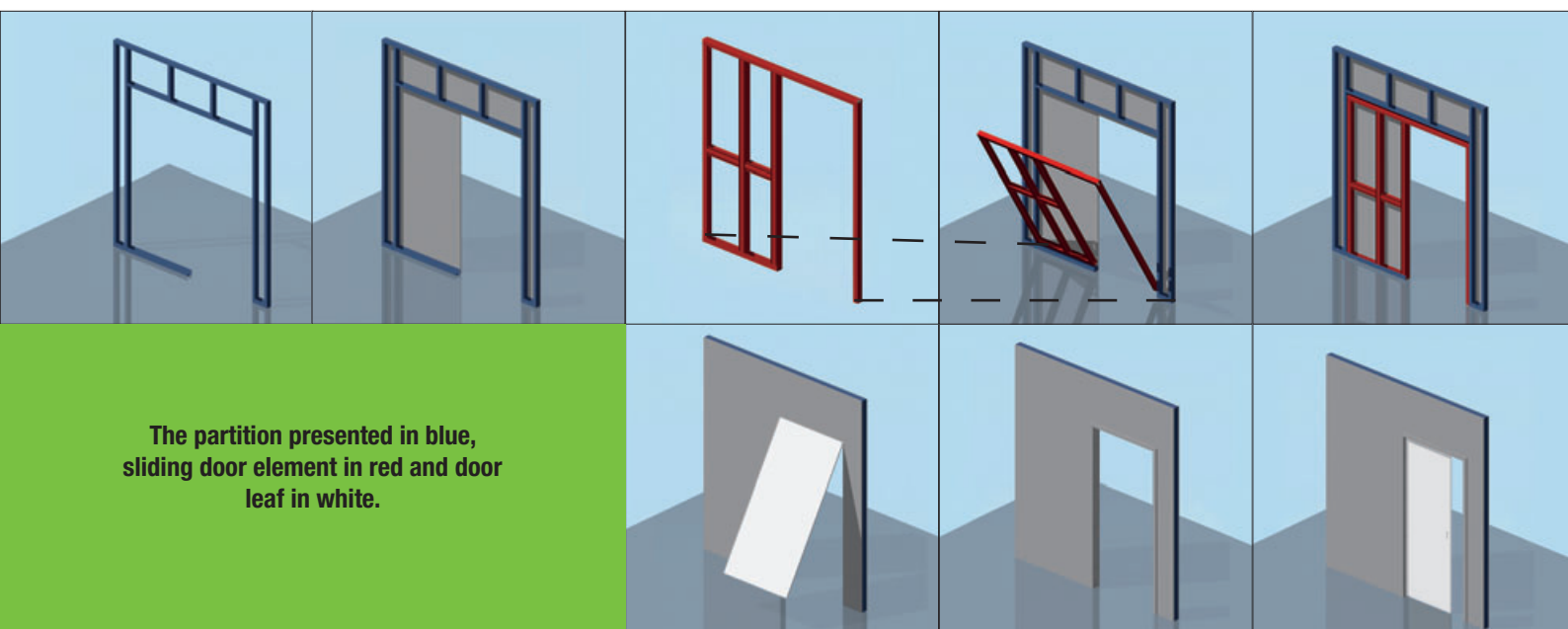

MATERIALS AND EQUIPMENT, STORAGE

The delivery of a LIUNE sliding-door unit includes the following components:

Sliding-door unit

The frame of the sliding-door unit is manufactured from hot-galvanized steel. The unit can be stored outdoors if protected, unless stated otherwise in connection with the delivery.

Door leaf and frame components

The door leaf and frame mouldings are packed in protective plastic and must be stored in conditions corresponding to those of their future use. The plastic protecting the door leaf should not be removed before the leaf has been installed in the sliding-door unit.

Door mechanisms

2 roller wheels for the door leaf are supplied with the unit. The other fittings of the sliding-door unit are ready-fitted to either the door leaf or the unit frame.

Installation screws

The plasterboard screws needed to install the sliding-door unit are supplied with the unit. Use only the attachments in the delivery to install the plasterboard.

Screw types:

Normal plasterboard countersunk screw, QSB 25
Hardened plasterboard countersunk screw, QSBR 25

Electrical accessories

There is a reserve for electrical installations inside the Liune element.



LOGISTICS

Transport packages and transport supports

IMPORTANT!

When moving a sliding-door unit on site, take care to ensure that the unit's sliding rail does not bend. The door unit's transport support cannot be removed until during installation.

If the rail has been damaged, the sliding-door unit must not be installed.

Support of the sliding-door unit

Transport supports are installed in the sliding-door unit for transportation. The transport supports should not be removed by unscrewing until the sliding-door unit is being installed.

The installation supports are located in the lower edge of the door opening and in the cross-brace in the centre of the structure.

Time of delivery of the sliding-door unit

We recommend that the Liune be delivered to the building site before one side of the frame has been boarded, to allow installation to start at once. If the unit is delivered earlier, it should be stored on site on a flat base, in either a vertical or horizontal position.

Moving the sliding-door unit on site



INSTALLATION INSTRUCTIONS

Building the partition wall (Sections 1–3)

	Doorway (width x height)	Element size (width x height*)	Element installation opening size
Li06	(610 x 2075 mm)	1335 x 2130 mm	1350 x 2170 mm
Li07	(710 x 2075 mm)	1535 x 2130 mm	1550 x 2170 mm
Li08	(810 x 2075 mm)	1735 x 2130 mm	1750 x 2170 mm
Li09	(910 x 2075 mm)	1935 x 2130 mm	1950 x 2170 mm
Li010	(1010 x 2075 mm)	2135 x 2130 mm	2150 x 2170 mm
Li012	(1210 x 2075 mm)	2535 x 2130 mm	2550 x 2170 mm
Double door size			
Li012	(1234 x 2075 mm)	2538 x 2130 mm	2558 x 2170 mm
Li014	(1435 x 2075 mm)	2938 x 2130 mm	2958 x 2170 mm
Li016	(1635 x 2075 mm)	3338 x 2130 mm	3358 x 2170 mm
Li018	(1835 x 2075 mm)	3738 x 2130 mm	3758 x 2170 mm
Li020	(2035 x 2075 mm)	4138 x 2130 mm	4158 x 2175 mm
Li022	(2234 x 2075 mm)	4538 x 2130 mm	4558 x 2170 mm

*observed parquet space, max. 40 mm.

1. Installation of the sliding-door unit starts with the building of the partition-wall frame. An opening for the unit is left in the partition-wall frame according to the dimensions given in these instructions. Dimensions are given below Li06-Li020 -door.

During installation, the lower edge of the sliding-door unit frame must be ready at the level of the finished floor surface, so that the final height of the installation opening to be made for the sliding-door unit depends on the height position of the floor level. An installation tolerance must be left at the upper edge of the opening, so that a so-called parquet clearance (= structural thickness of the surface construction of the floor) will remain below the sliding-door unit. In the drawing, a 40-mm parquet clearance has been left between the unit and the wall frame. The surface construction of a floor thicker than this must be allowed

for when building the partition wall – especially in the height of the installation opening. The height of the door leaf can be adjusted later by about 5–10 mm, with the aid of the door mechanisms.

2. The wall is boarded ready on one side, before installation of the sliding-door unit. The wallboard must not be screwed at the lower rail before the Liune is in place. The boarding and size of the door opening are dimensioned in the drawing.

3. A hole with a minimum size of \varnothing 17 mm is made in the rail above the door unit for the electric conduit (16 mm), on the edge of the side with the electric point/switch. The distance of the holes (872 / 972 / 1072 / 1172 mm) in the drawing is dimensioned from the vertical framing on the door-opening side of the partition wall.

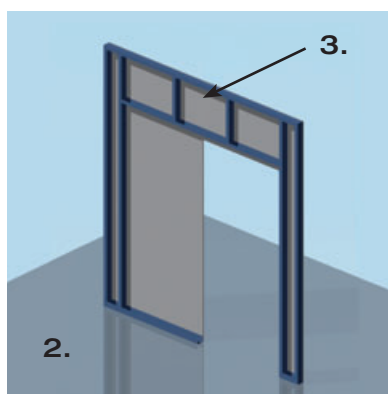
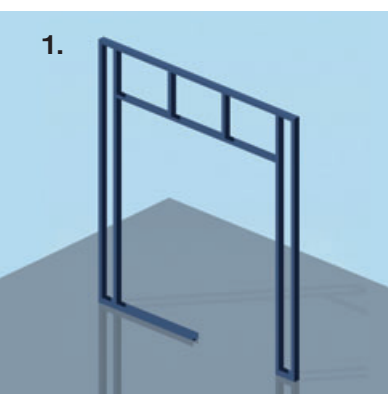

INSTALLATION INSTRUCTIONS

Sectional view 1:20
Wall frame

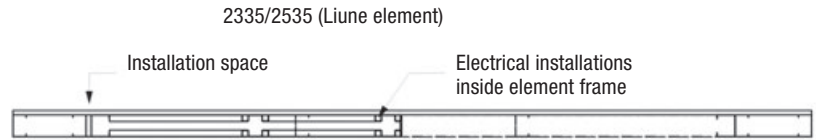

Facial view 1:20,
wall frame and
the sliding door unit

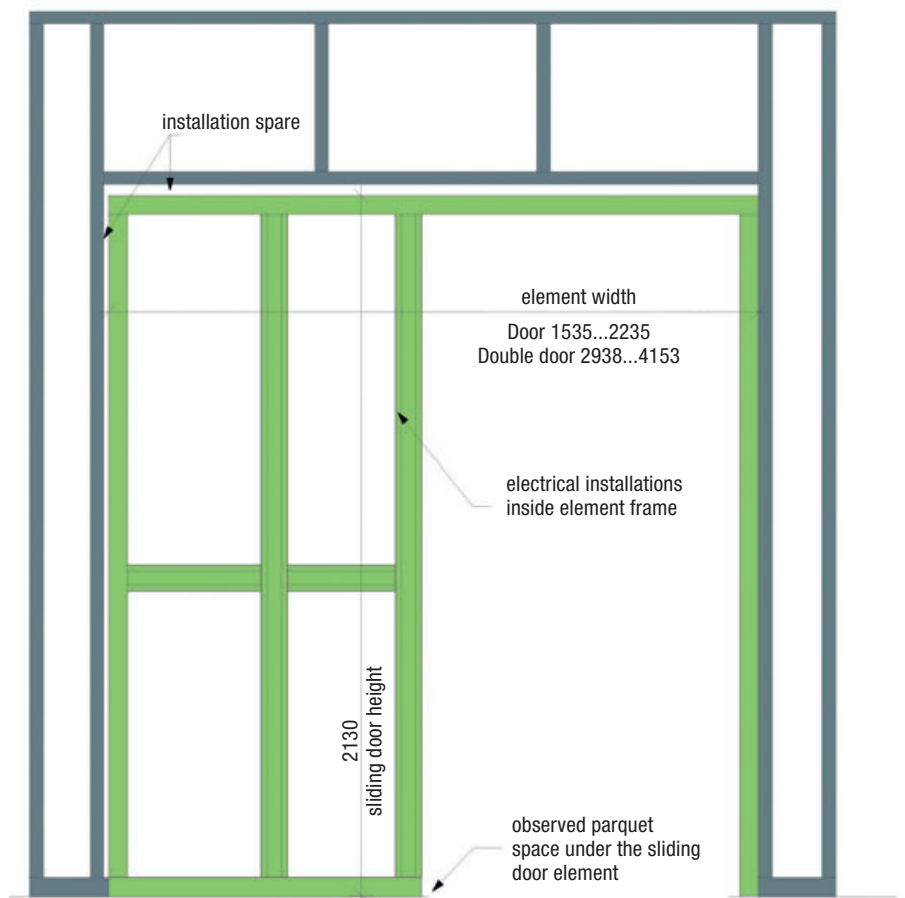

Sectional view 1:20,
wall frame and 1. boarding

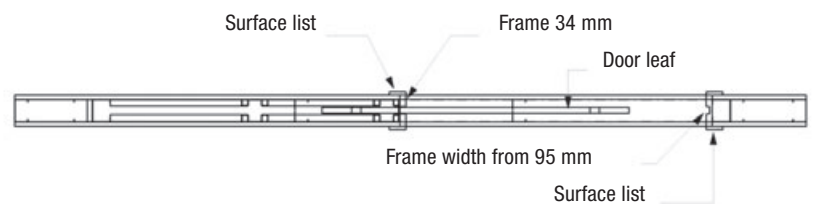

INSTALLATION GUIDE

Installation of the LIUNE sliding-door unit (Sections 4–10)

4. The transport supports are removed from the cross-brace and door opening of the unit, from the boarded side of the wall. The support can still be left in the door opening on the unboarded side. At this stage, the screws of the other transport supports must be removed from the unit.

5. Lifting the Liune into place. The unit is lifted by placing its lower edge on the rail in the partition wall and pushing the unit into place against the boarded wall.

6. The unit is raised to the correct floor height, for example, with the aid of wedges. These are used to adjust the so-called parquet clearance..

7. Check the horizontality of the unit. The Liune must be completely horizontal before it is secured.

8. Securing takes place first from the boarded side of the wall.

9. Cleaning the unit. Ensure that the sliding rail is clean before boarding the second side of the wall.

10. Boarding and screwing of the second side of the unit Li08 – 430 mm from the edge of the door, with a second screw line 800 mm from the edge of the door. Screw spacing according to the board-manufacturer's instructions.

11. The sliding door leaf can be installed after Sections 7–9. It is essential to check the cleanness of the sliding rail again after removing the protective tape from the door's sliding opening.

IMPORTANT!

Use only the plasterboard screws supplied with the delivery to install the Liune.

5.

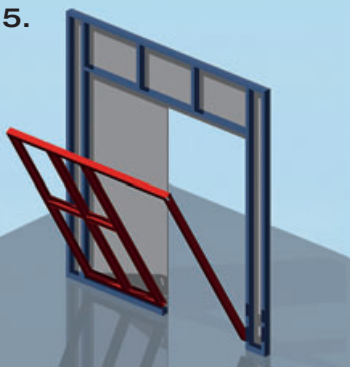

7.

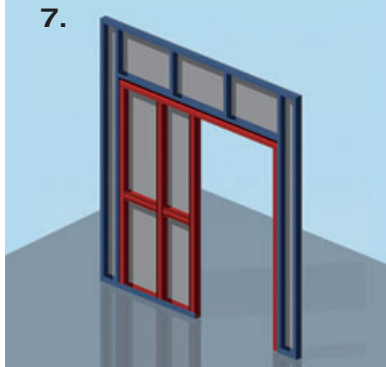

INSTALLATION GUIDE

Sectional view 1:20

Wall frame

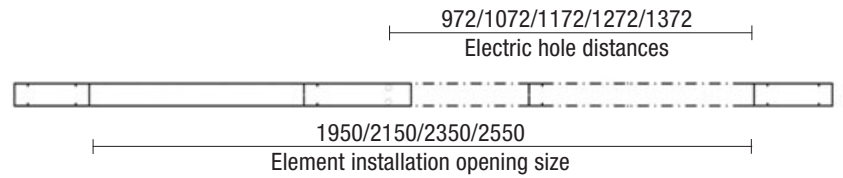

The wall frame, 1. boarding

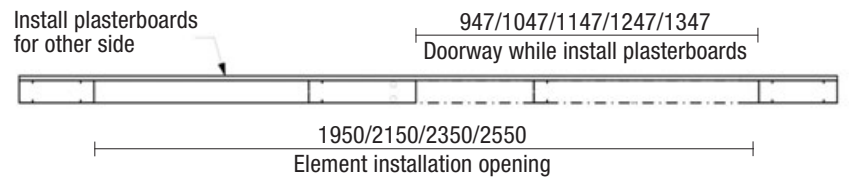

Sectional view 1:20

The wall frame, 1. boarding
and the sliding door unit

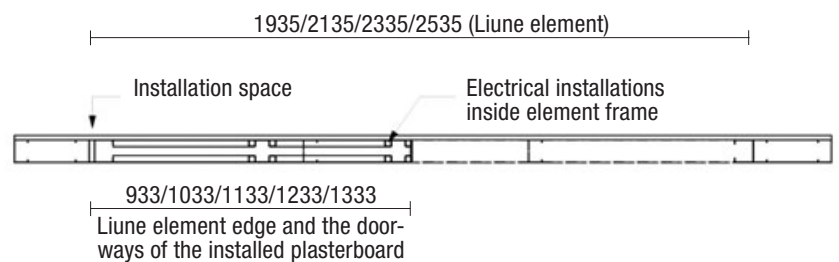

Sectional view 1:20, wall frame,
sliding door unit and
boarding both sites

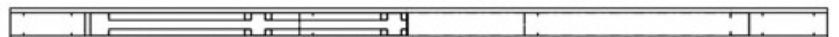

INSTALLATION GUIDE

Installation of the door leaf (Sections 11-16)

Important!

Installing the door be careful not to damage the door leaf.

12. Place the roller wheels on the sliding rail.

13. Check the spring catches.

When installing the door, the spring catches should be set in the position, in which the catches are inside the door, i.e. in the CLOSED position.

14. Lift the door and attach it to the roller wheels.

- a.** Place the groove in the lower edge of the door onto the T-rail in the door unit.
- b.** Lift the upper edge of the door close to the attachment bolts. The attachment bolts are set in the attachment plate in the upper edge of the door, with washers on both sides of the plate.
- c.** The door's attachment nuts are tightened and the door adjusted so that it does not rest on top of the T-rail. The final alignment and height position of the door are ensured during the installation of the frame's cover strips.

15. Liune sliding doors are installed at the same time as other door-leaf installations.

16. Doors installed on the building site are pushed back to the protected position inside the structure and protected with a strip.

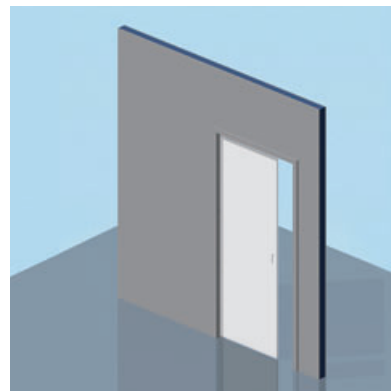
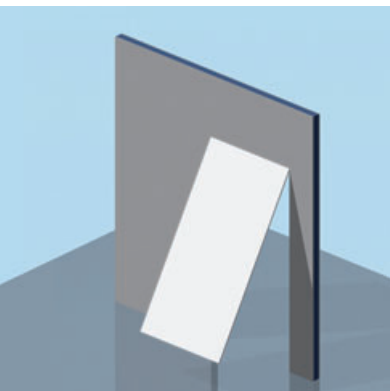

INSTALLATION GUIDE

Installation of MDF frame cover strips and alignment of door (Sections 17–20)

17. After boarding the wall, the gap for the door leaf must be checked carefully from both top and bottom, to secure its straightness.

- unit 70mm gap 25mm
- unit 95mm gap 55mm
- unit 120mm gap 79mm

18. The door's narrow upper frame cover strips are installed on both sides of the door.

19. Installation of the MDF frame cover strips is started from the wide counter frame. After installation check the vertical alignment, the door must be in totally vertical position. Adjust the height and verticality with the aid of the roller-wheel attachment bolts.

20. The narrow vertical frame cover strips are installed on both sides of the door gap.

21. The narrow upper cover frame strip is installed last.

22. The cover plugs are installed in the screw holes of the frame.

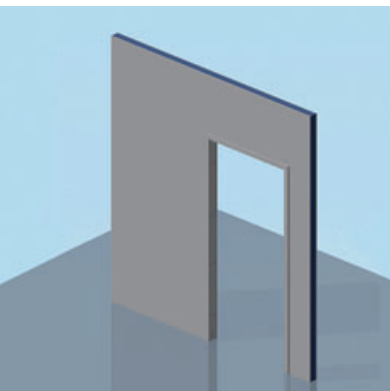



Liune Door sales office:

Aulis Lundell Oy
Turuntie 198
03100 Nummela
Finland

Tel. +358 20 7341 400

liune@aulislundell.fi

www.liune.fi

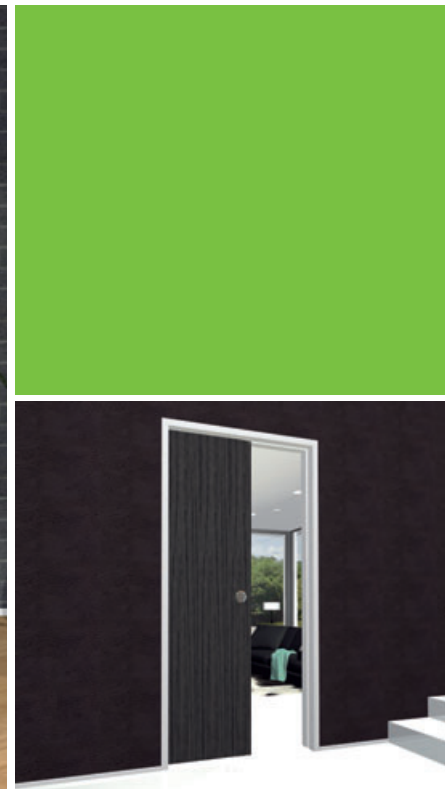

Operation of Aulis Lundell Oy has been certified according to iso 9001:2008 standard.



The environmental register of packaging
Pyr Ltd since 2004.

Liune Door is patented No FI 7139 - 16.11.2005.

