

VAROITUS suomi

Kokonaisen elementin siirrot työpareittain, jotta elementtiin ei kohdistu vääntöliikettä! Kuljetuksessa vaurioitunutta elementtiä ei saa asentaa, merkinnät rahtikirjaan!

WARNING svenska

Vid förflyttning av hela element behövs ett arbetspar för att elementet inte ska utsättas för vridkrafter! Element som skadats vid transport får inte installeras. Gör en notering i fraktsedeln!

WARNING english

A two man work team is needed to avoid torsional forces when moving the whole frame! Frames that have been damaged during transportation are not to be installed. Describe the damage in the consignment note!

WAARSCHUWING Nederlands

Verplaats het complete element met twee personen om torsiekrachten te vermijden! Elementen die zijn beschadigd tijdens transport dienen niet te worden geïnstalleerd. Noteer de schade op de vrachtbrief!



LIUNE DOOR / +358 207 341 400

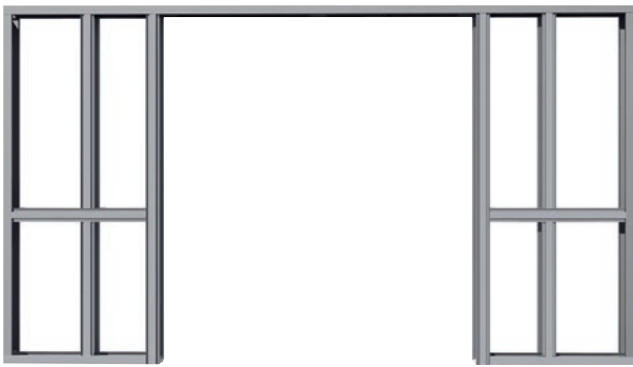

1 x

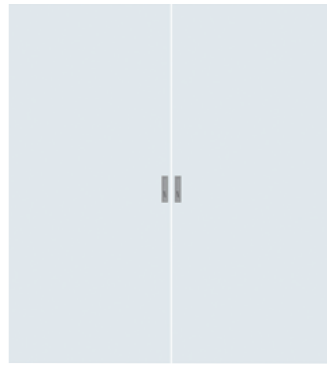

2 x



1 x



4,3 x 16
10010

30 x



3,6 x 22
10020

300 x



4,2 x 25
10030

25 x



20010

25 x



30010

4 x



40010

1 x



40020

1 x



40030

1 x



30020

2 x



30030

2 x



30040

2 x



50050

2 x



10 mm
50010

6 x



15 mm
50015

6 x



20 mm
50020

6 x



40 mm
50040

6 x



4 x



4 x

Asennusmitat | Installation dimensions

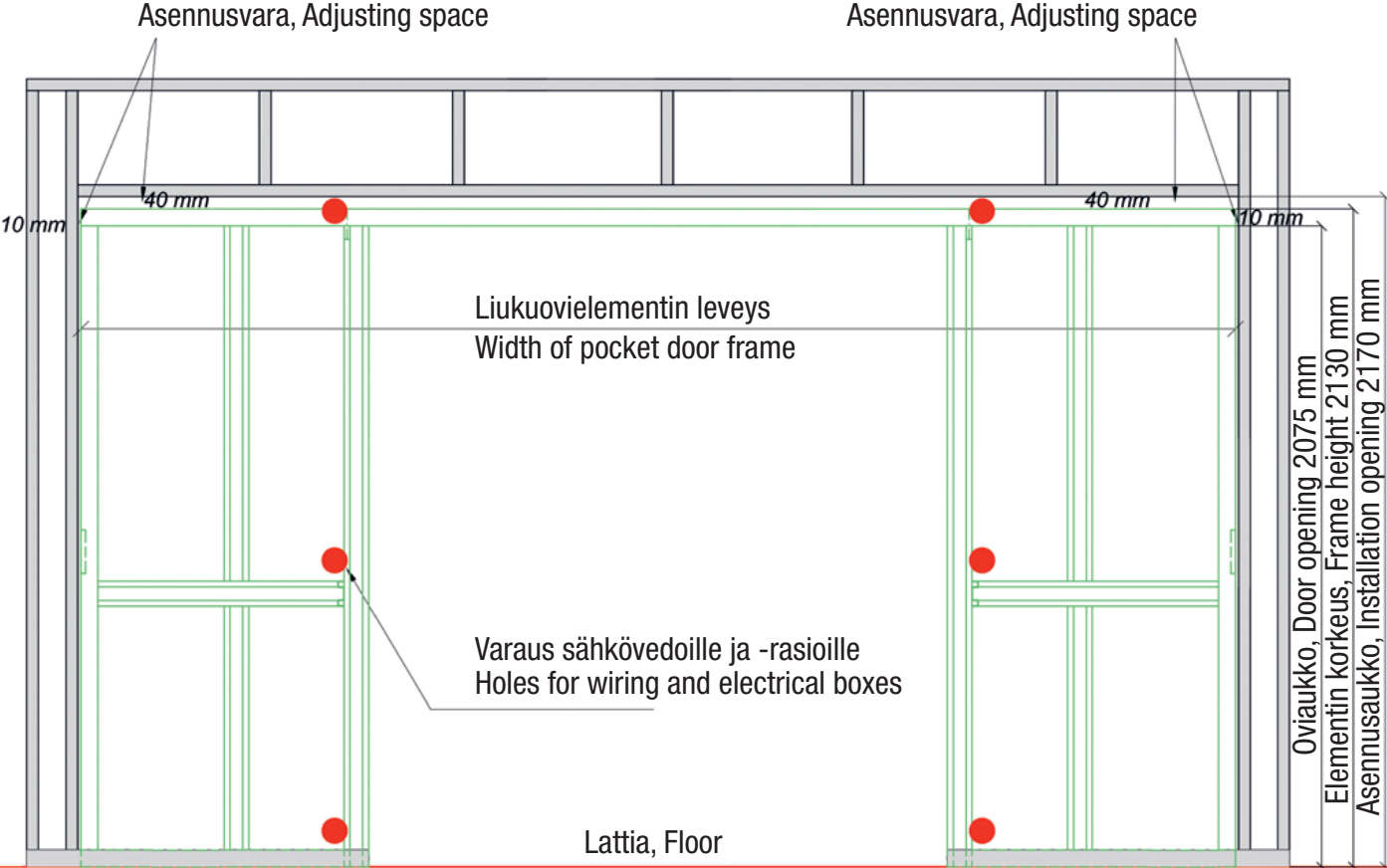

Asennusmitat | Installation dimensions

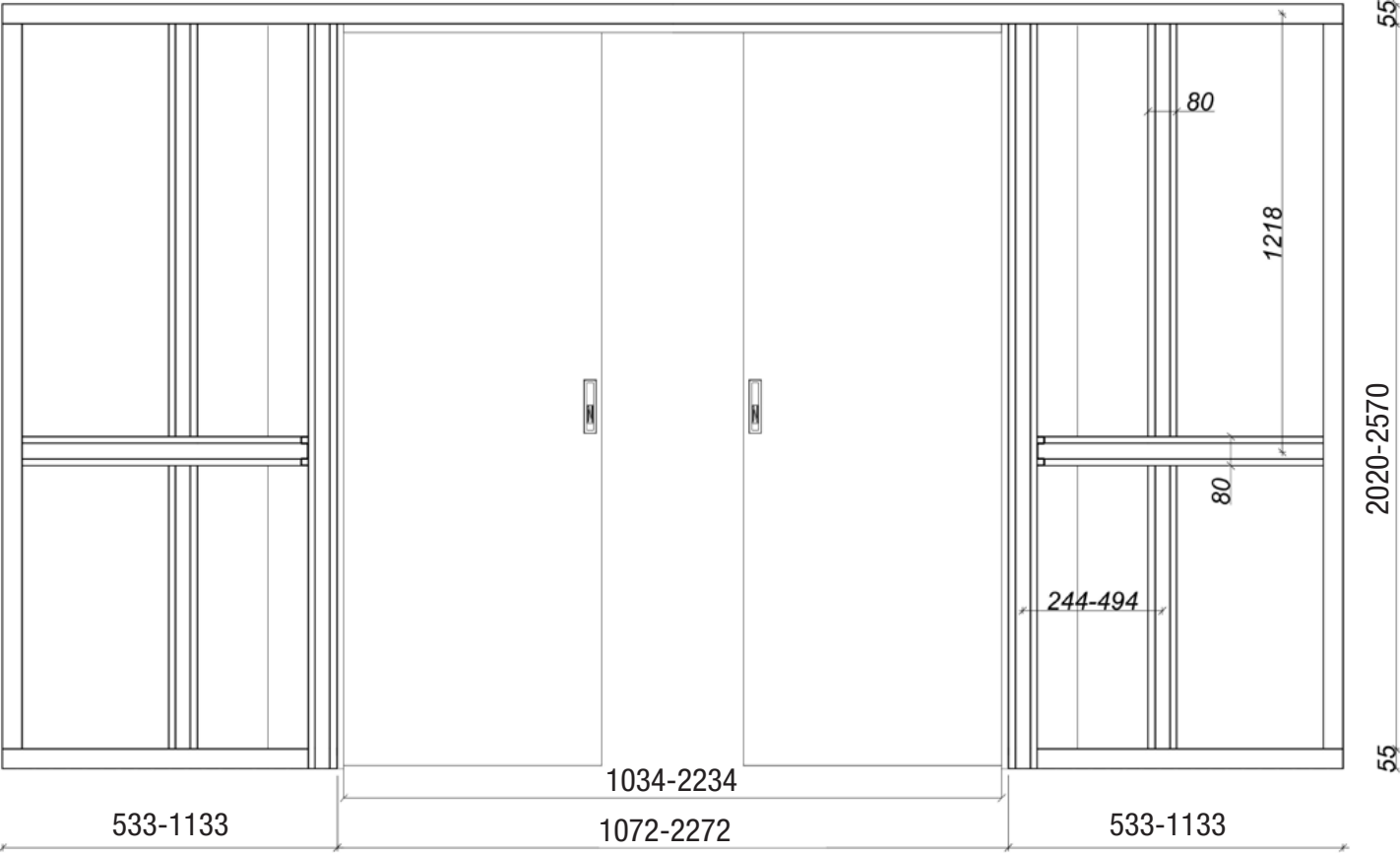

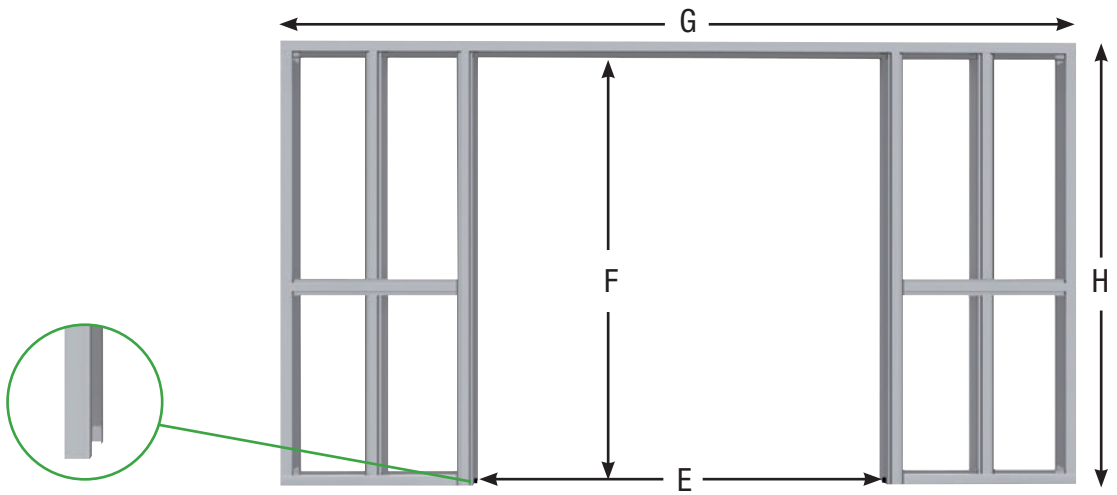
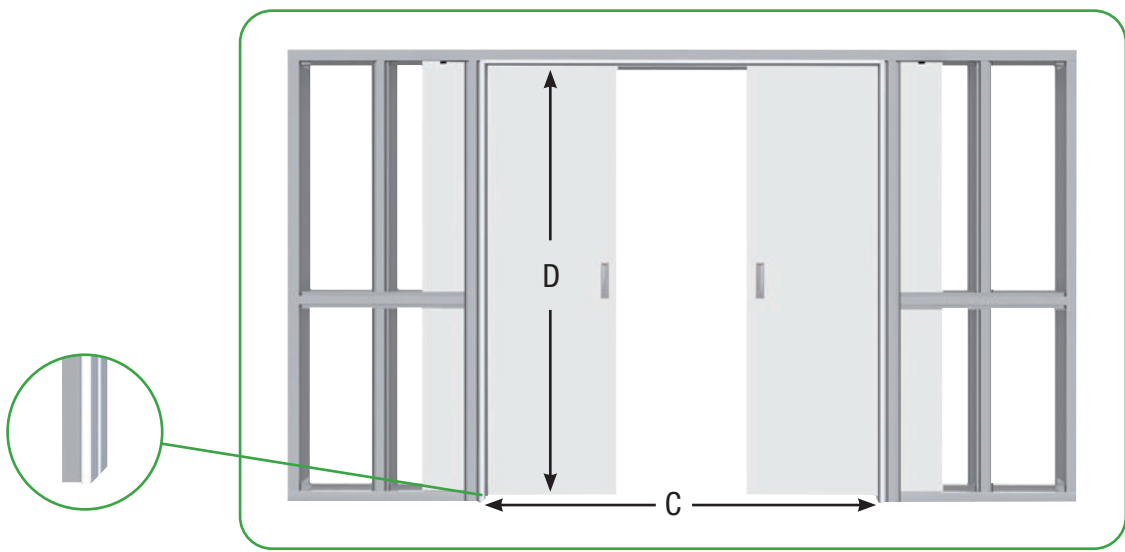
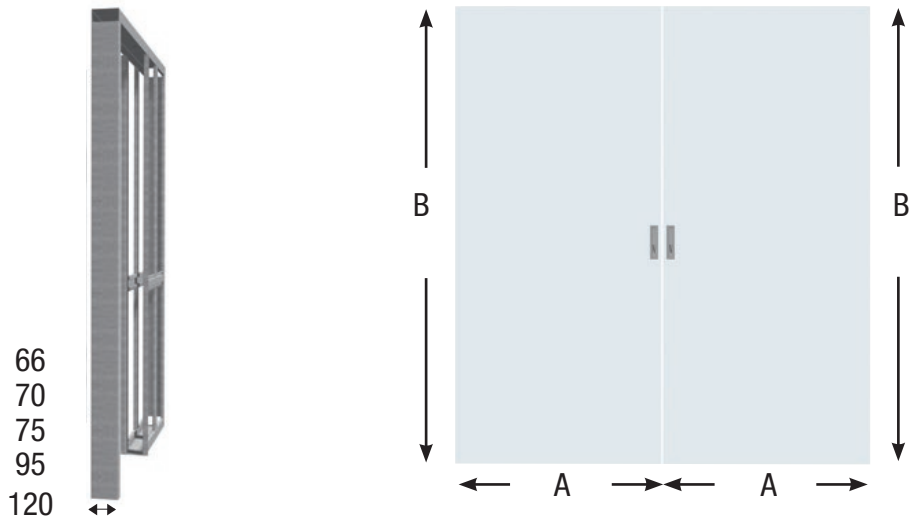

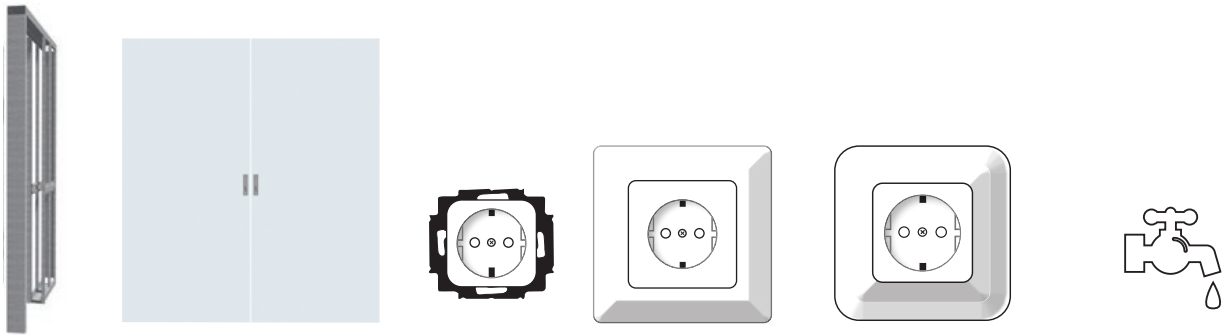

66 mm		X	X	X	X
70 mm		X	X	X	X
75 mm		X	X	X	X
95 mm	8 mm	X	✓	✓	X
	25 mm	X	✓	✓	X
	32 mm	X	X	✓	X
	40 mm	X	X	✓	X
120 mm	8 mm	✓	✓	✓	✓
	25 mm	✓	✓	✓	X
	32 mm	X	✓	✓	X
	40 mm	X	✓	✓	X

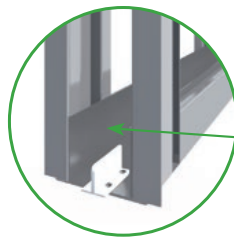

1

6 x

62 x 45 mm



10 mm 50010



15 mm 50015



20 mm 50020



40 mm 50040

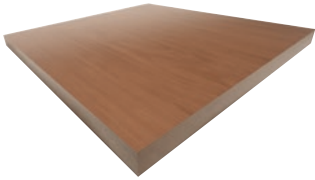

10 mm



10 mm 50010

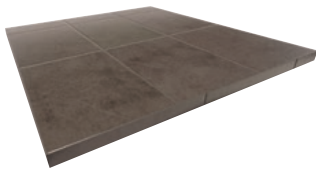

12 mm



15 mm 50015



18 mm



20 mm 50020

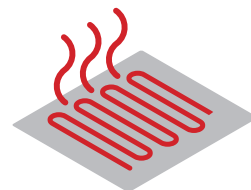
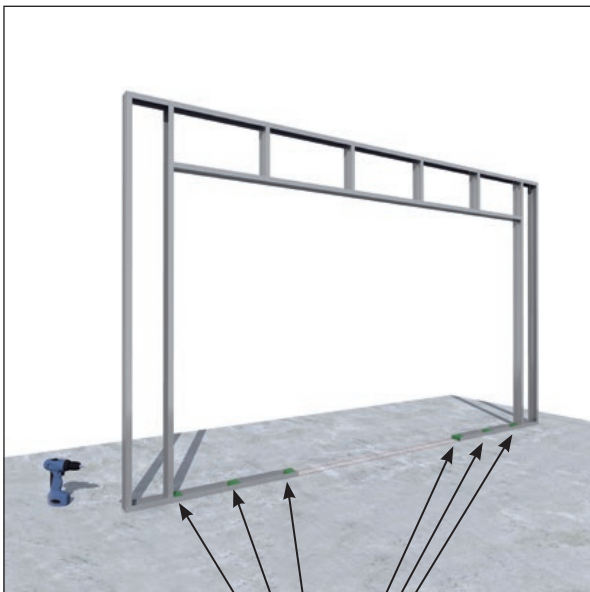
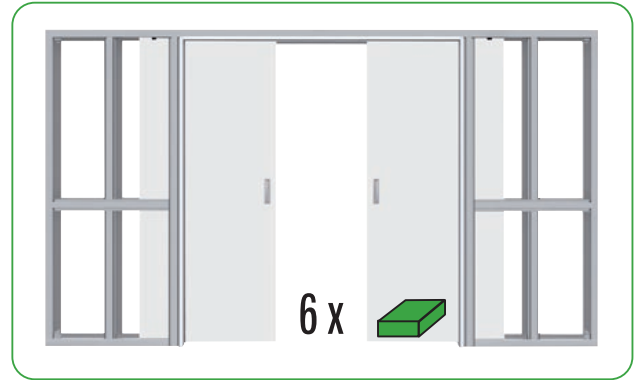

2

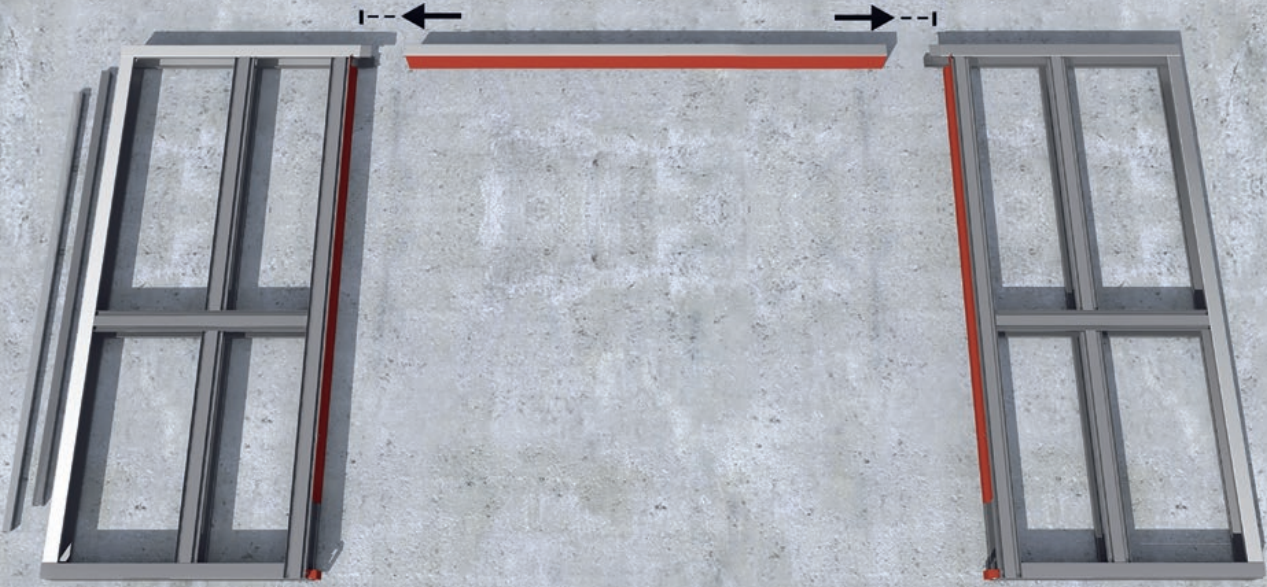

3

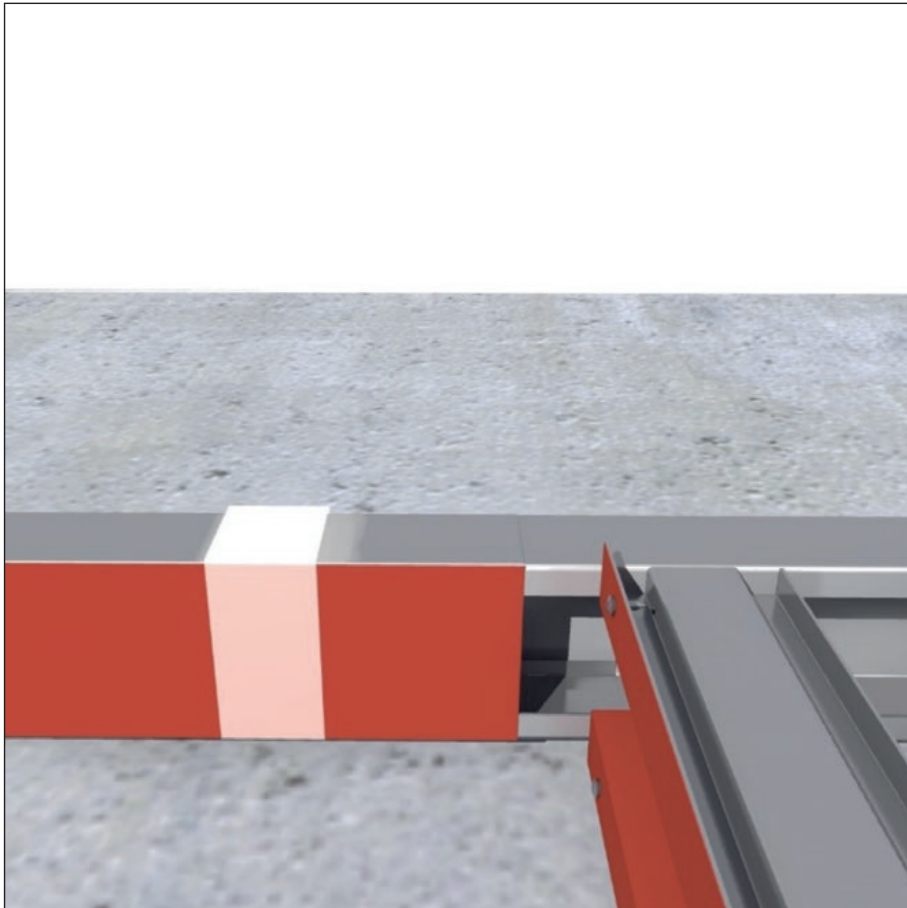
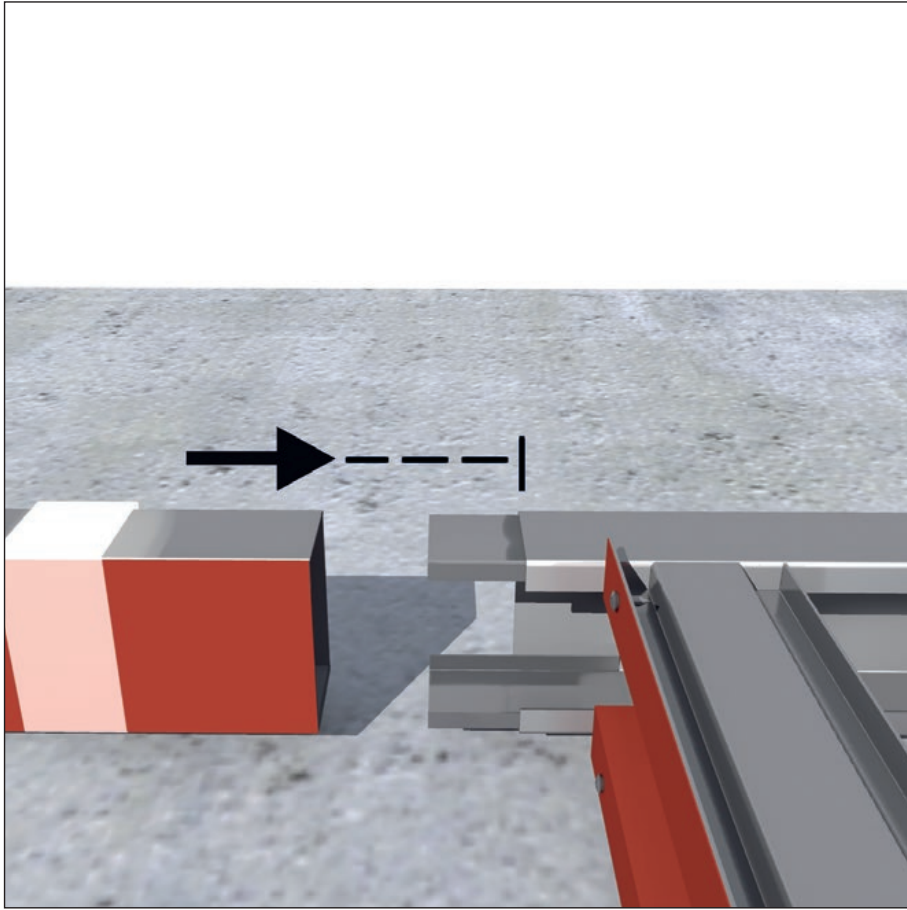

4

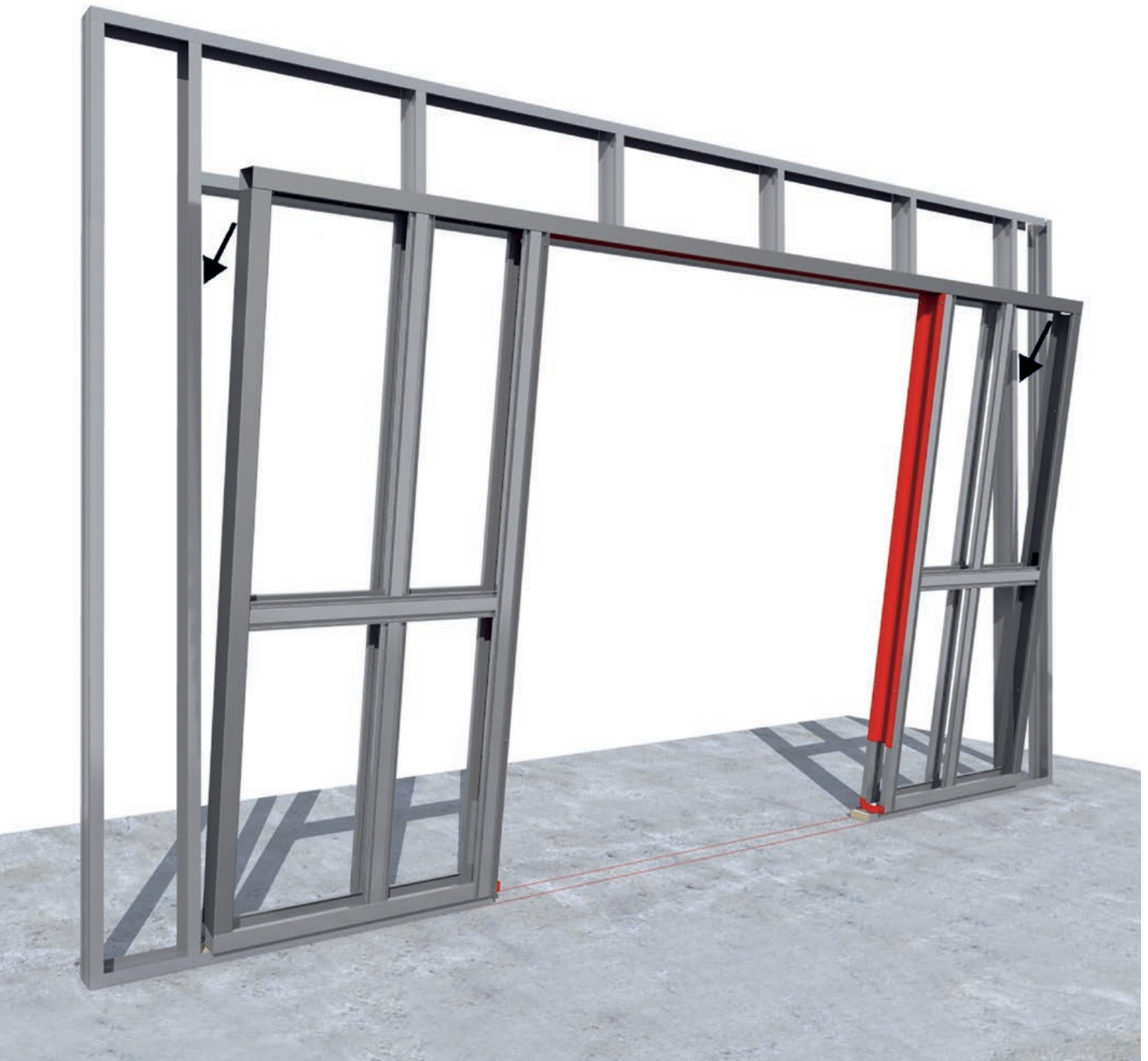

5

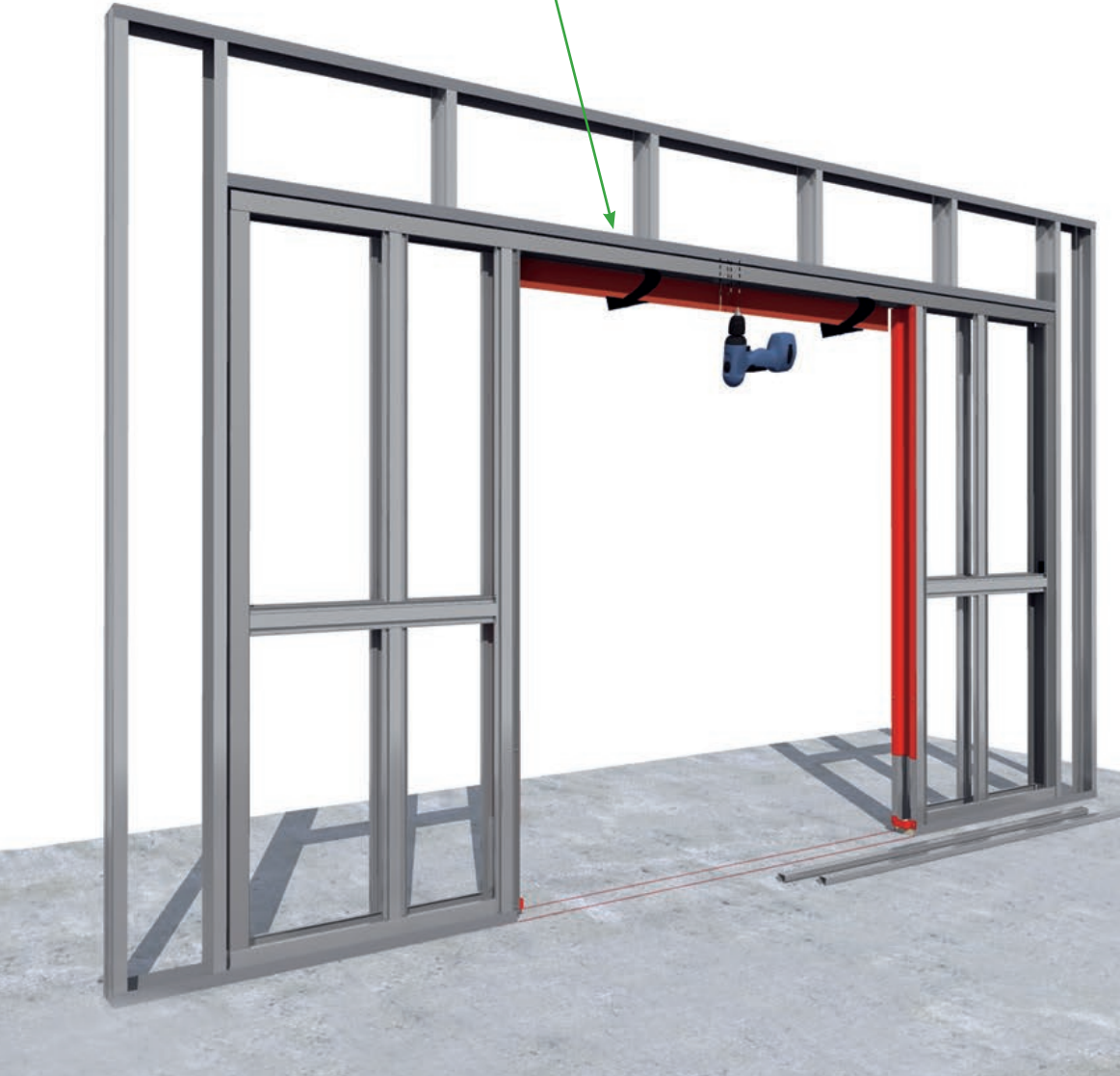
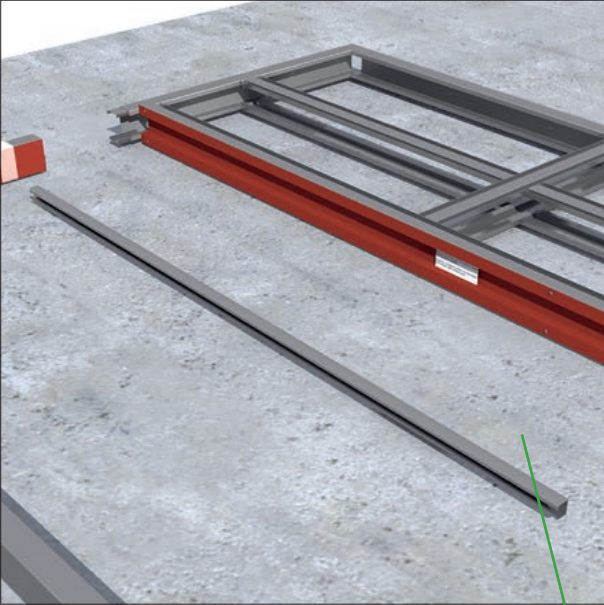

10010

30 x



6

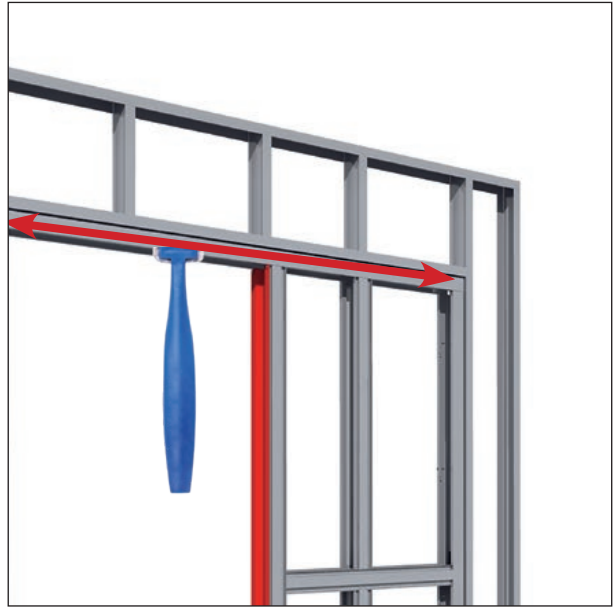
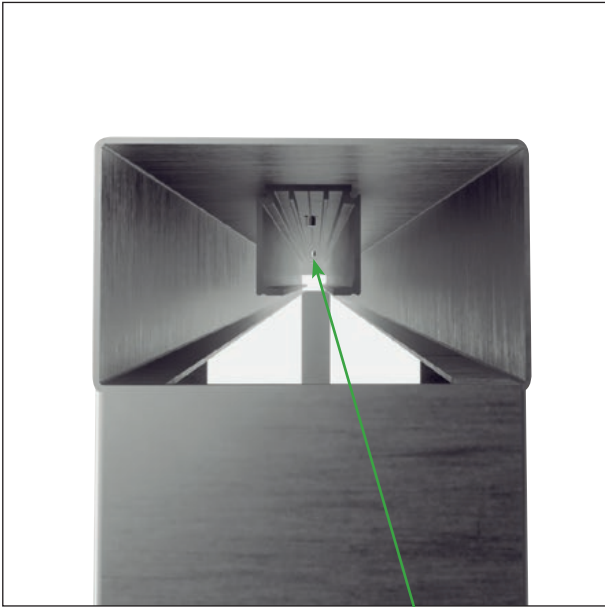

40020
1x



7



8

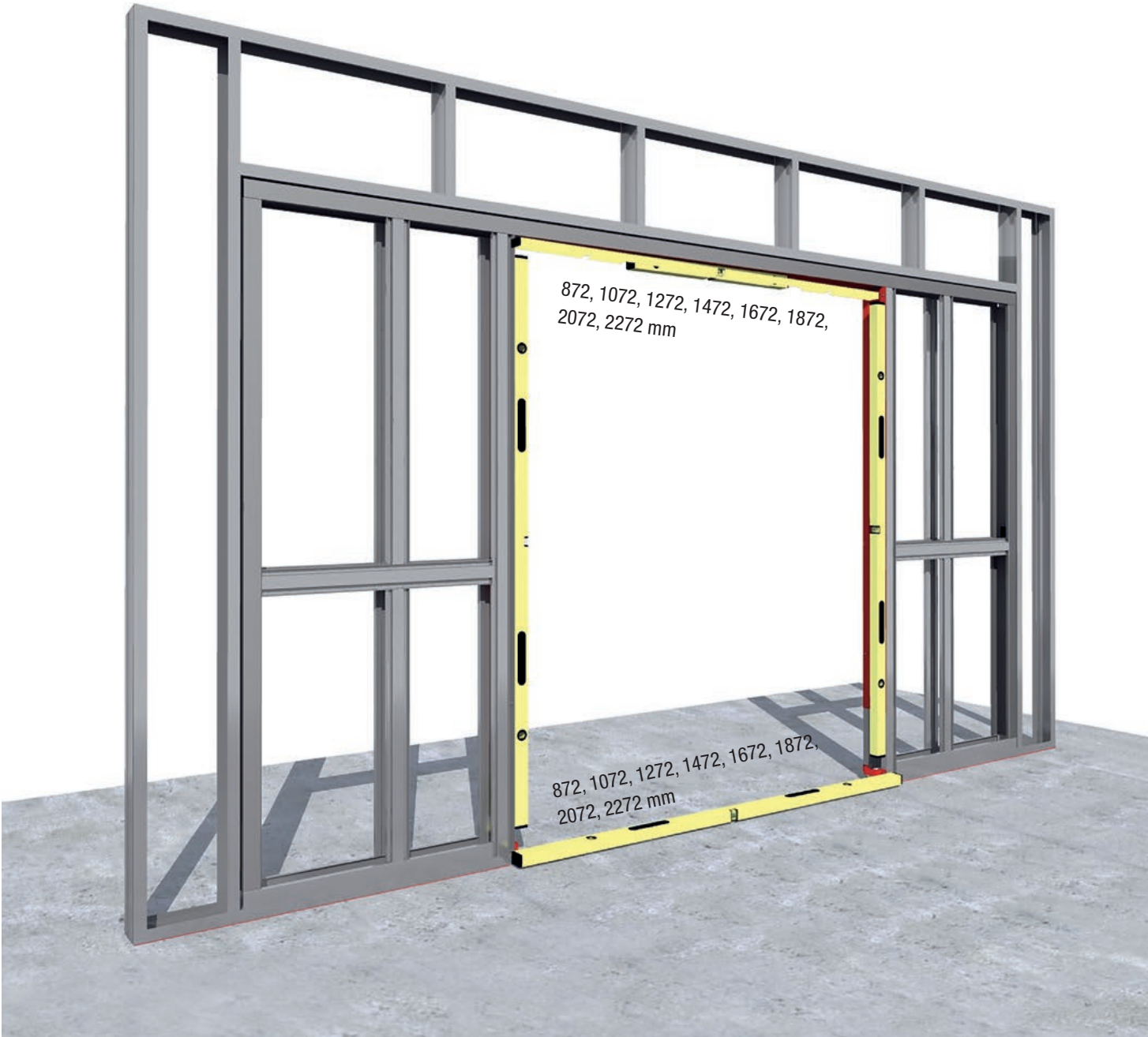

9

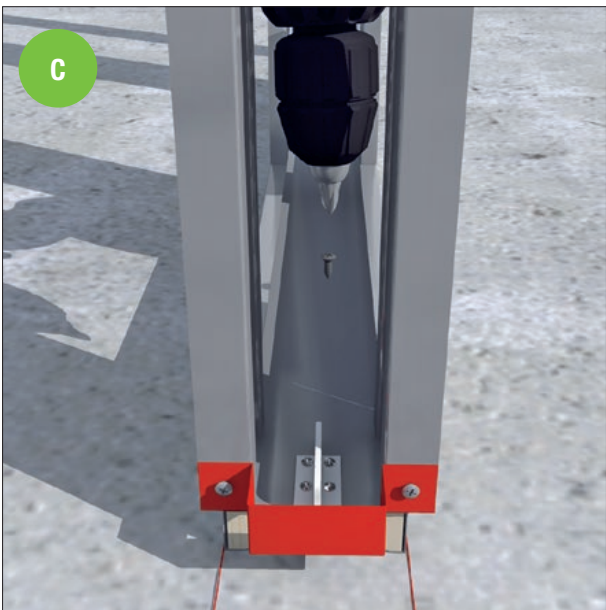
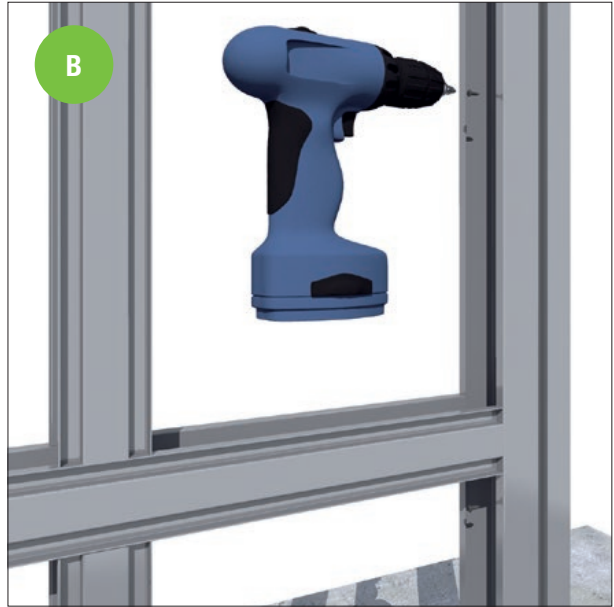
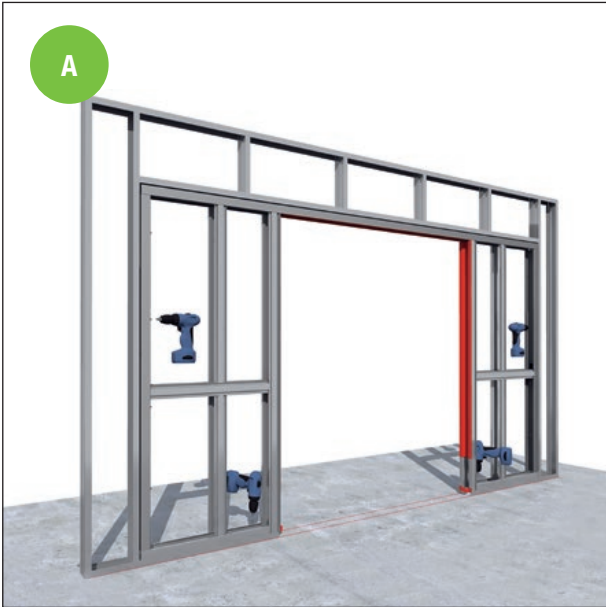

10



10020

300 x

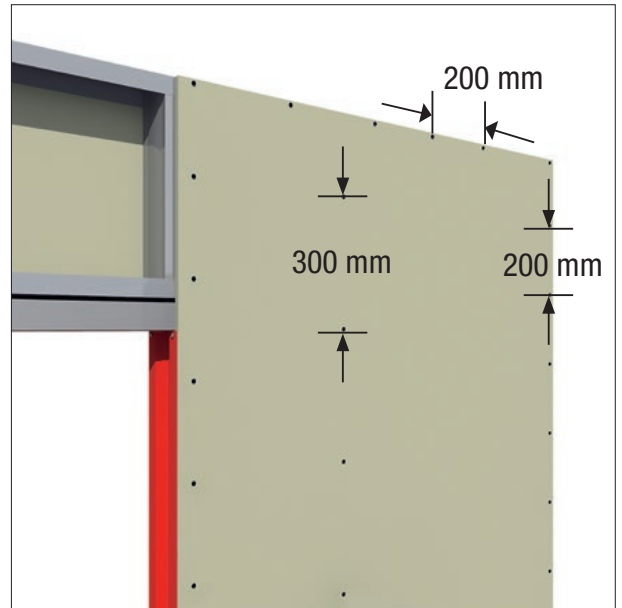

A



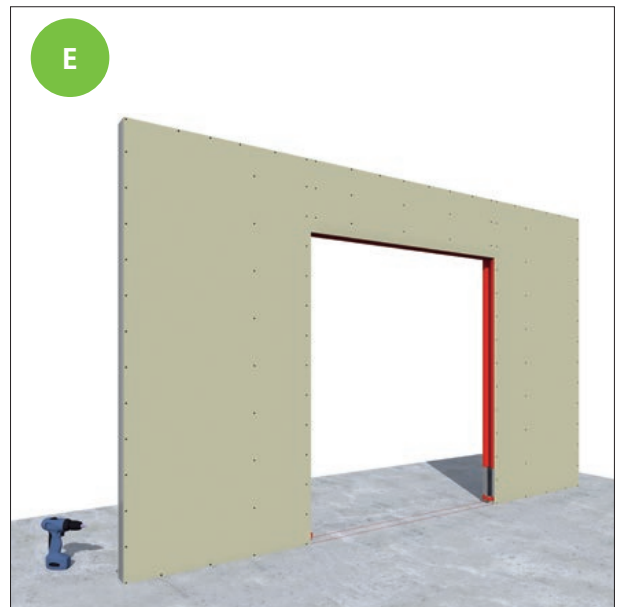
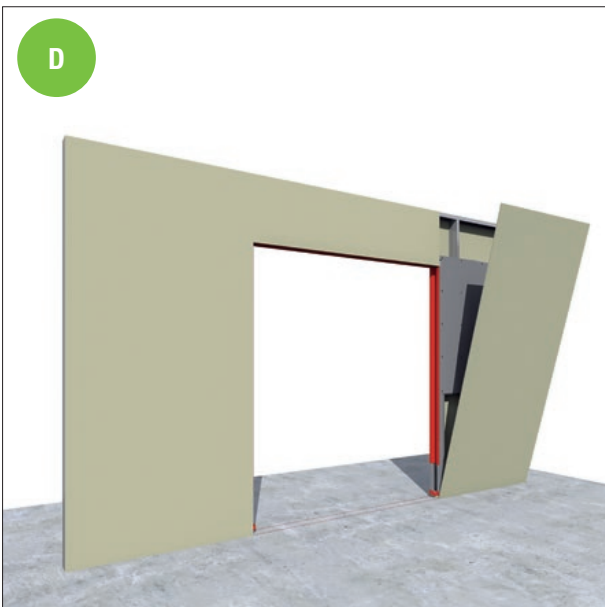
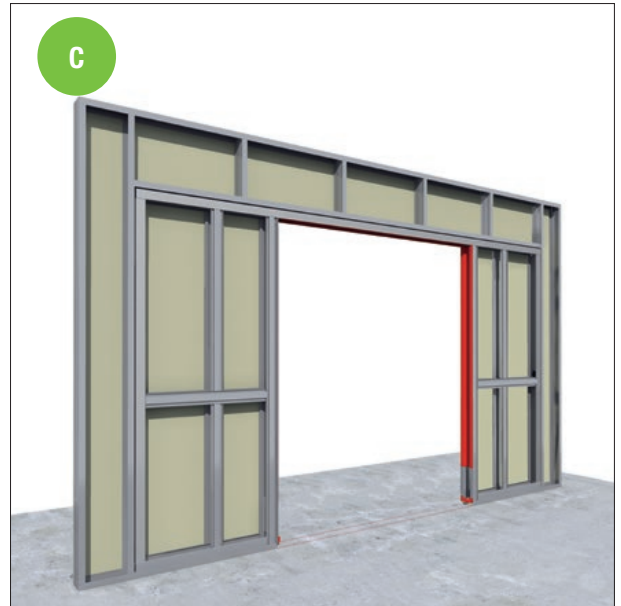
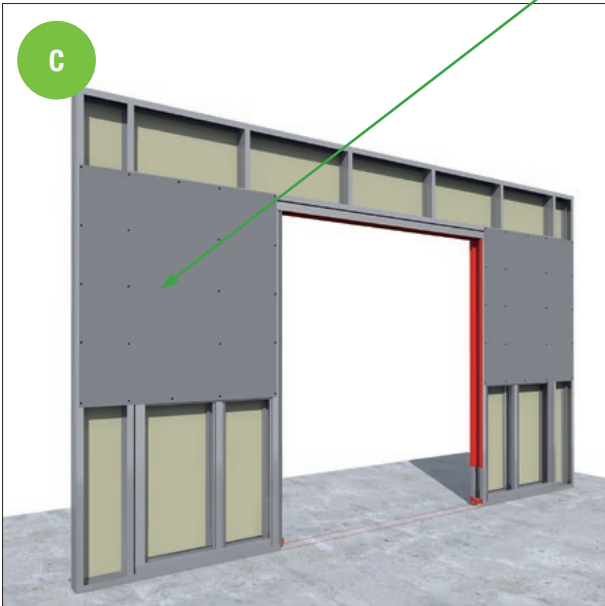
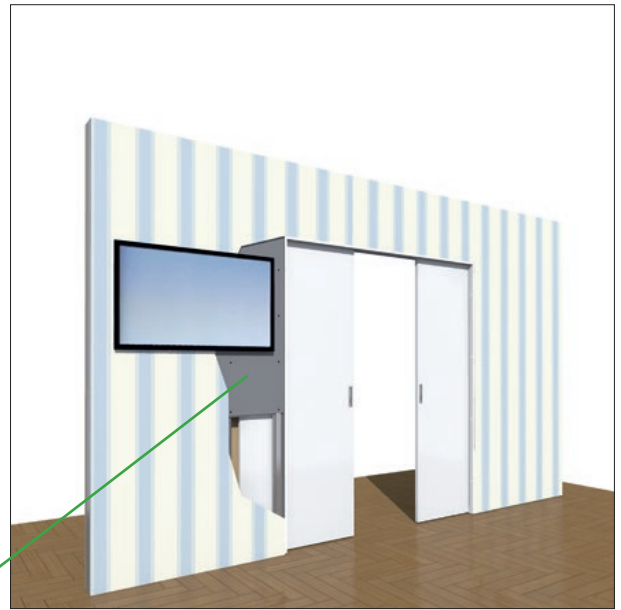
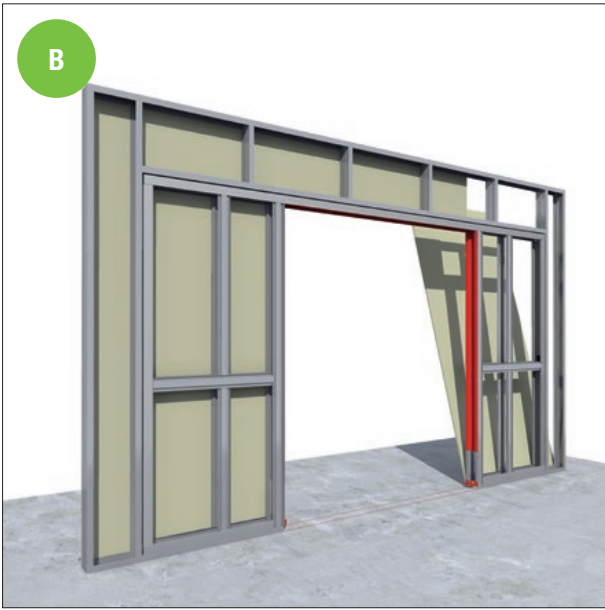

11

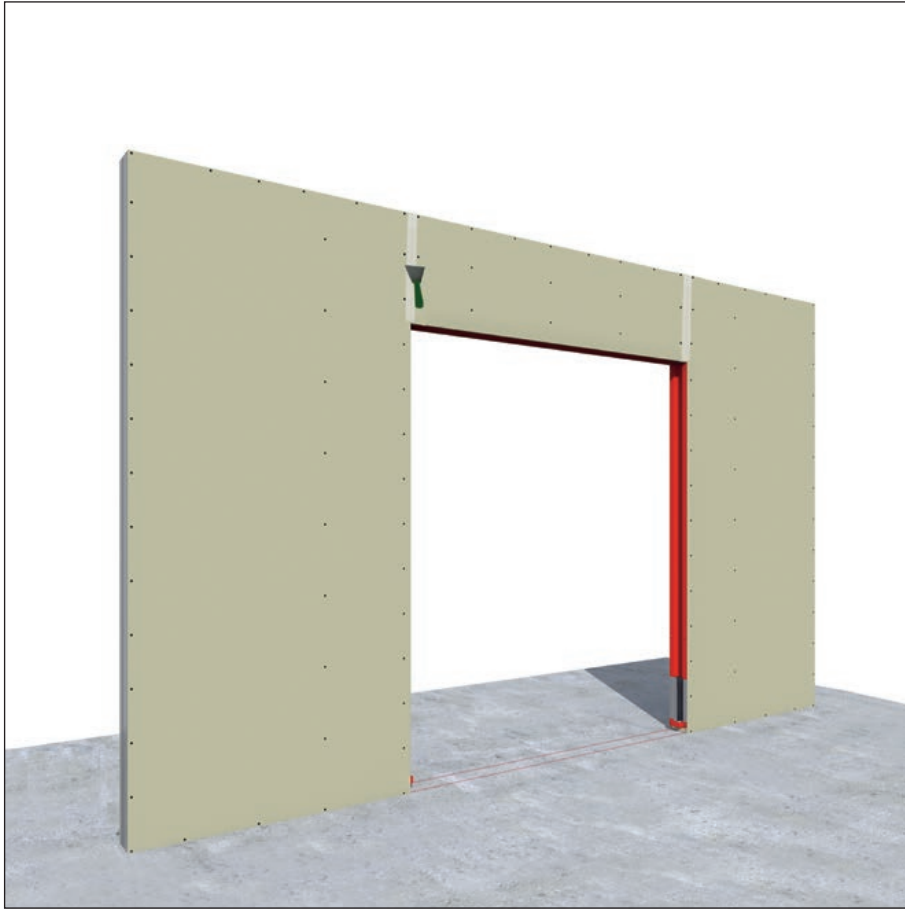

12



13

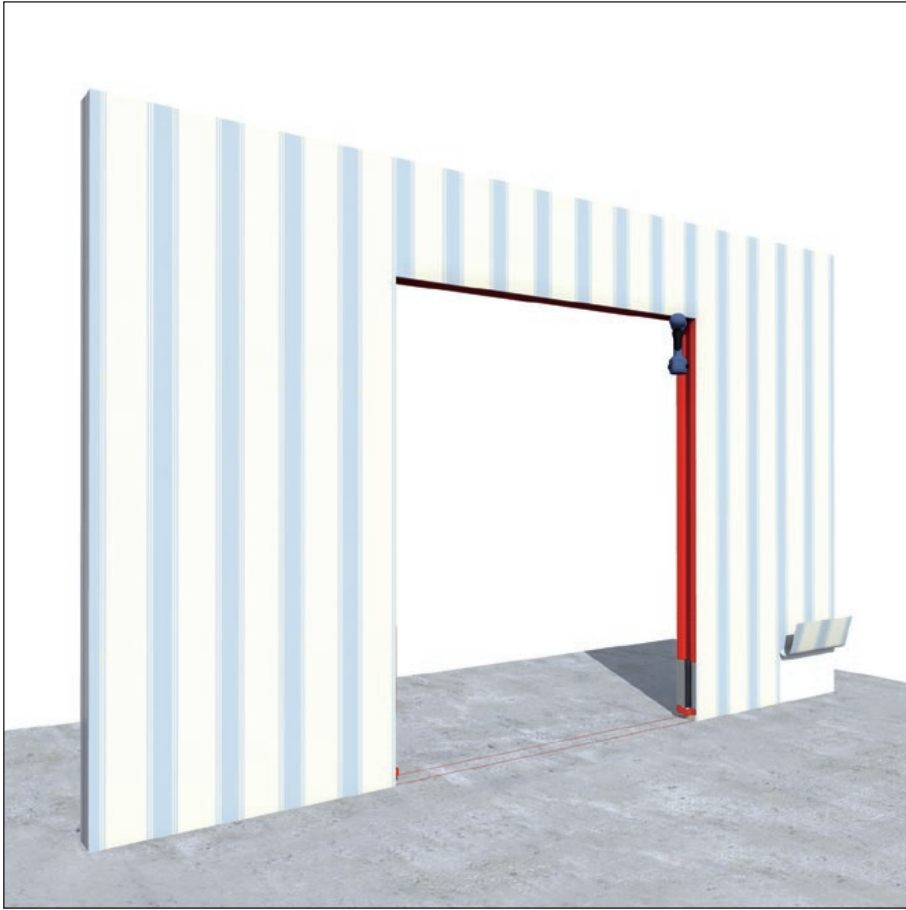

14

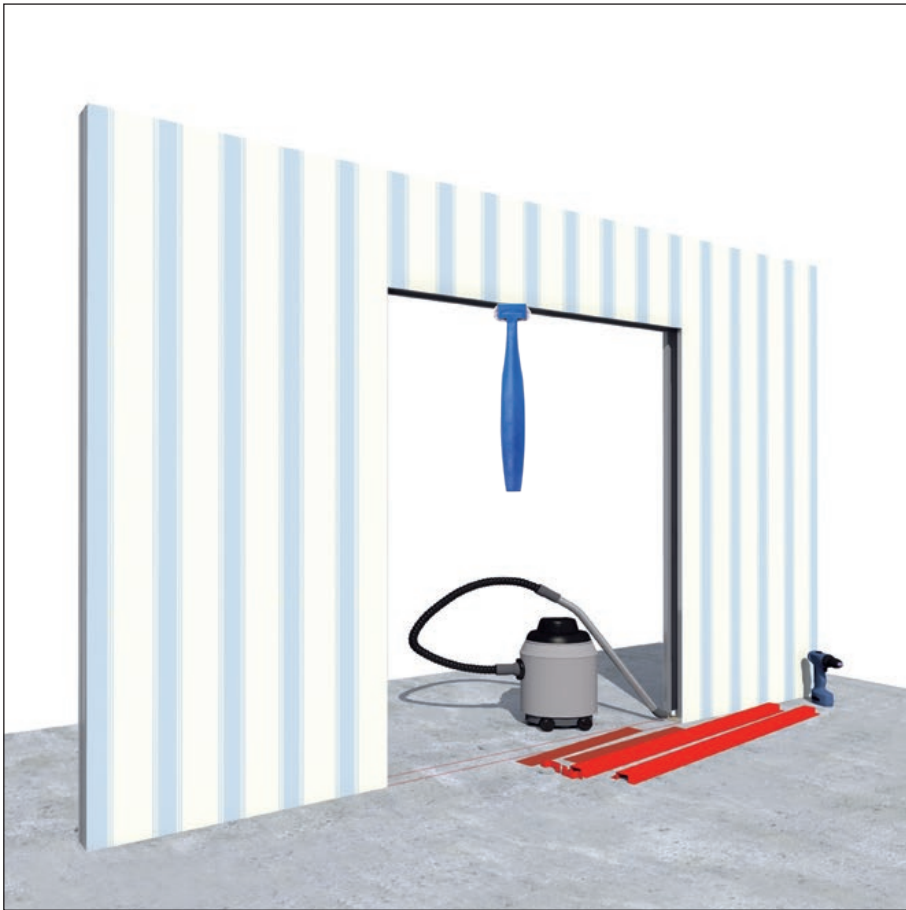

15

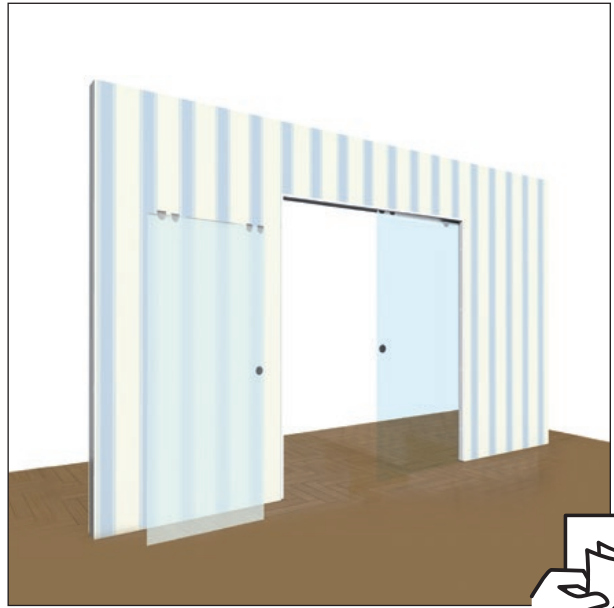
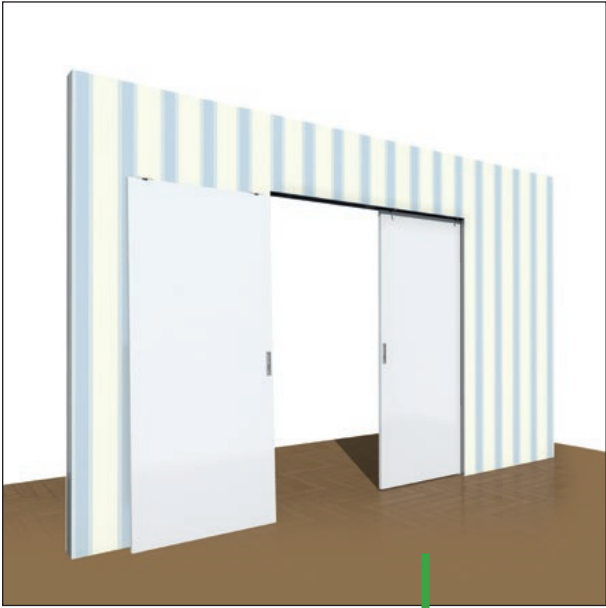

8 x



2 x

A

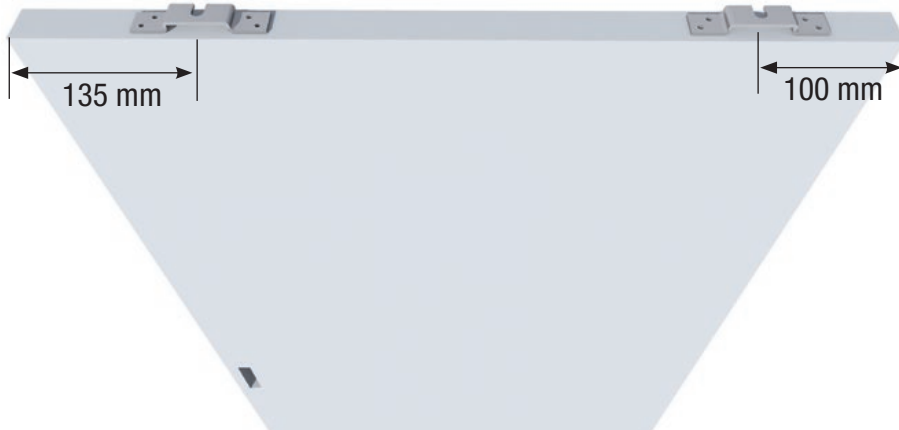

B



16

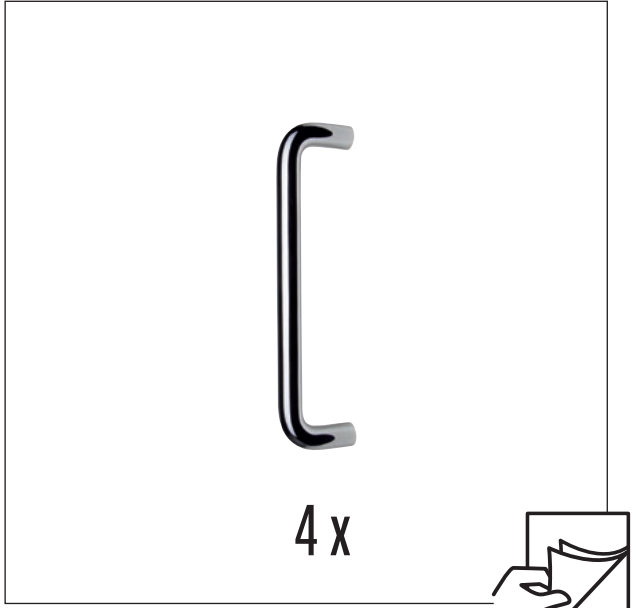

A

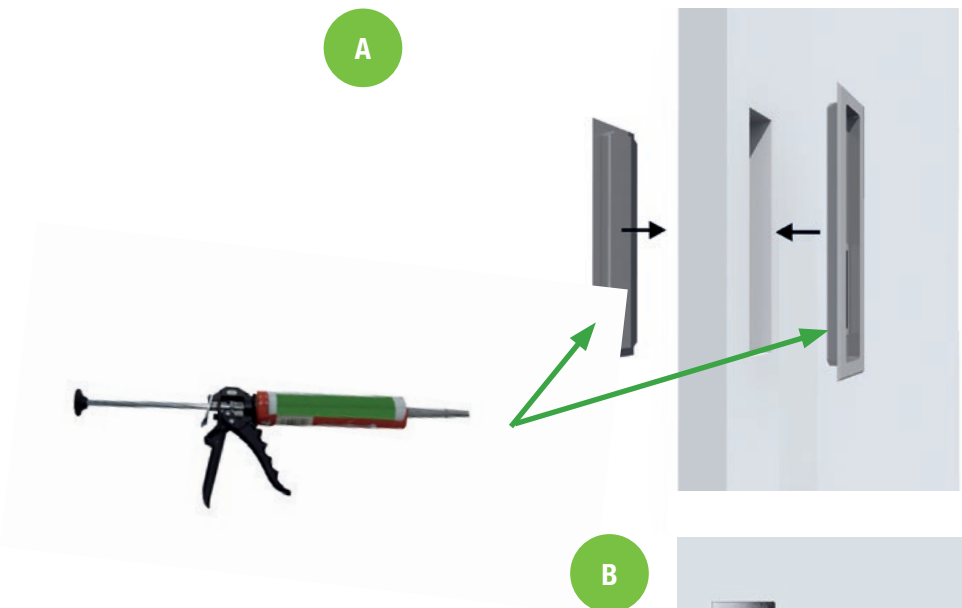

B



LI06, LI07, LI08, LI09



2 x

2 x

C

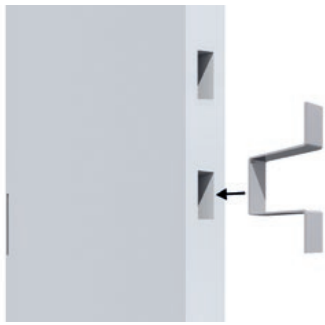

D

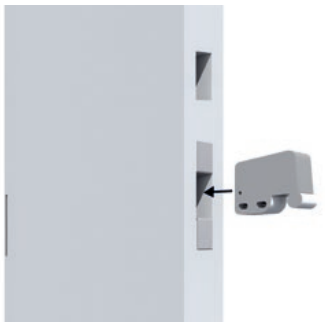

E



LI10, LI11, LI12



4 x

4 x

C

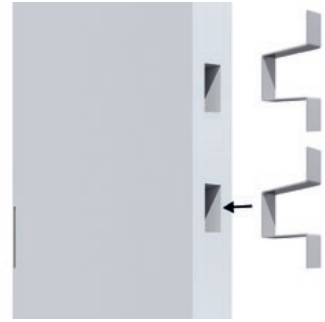

D

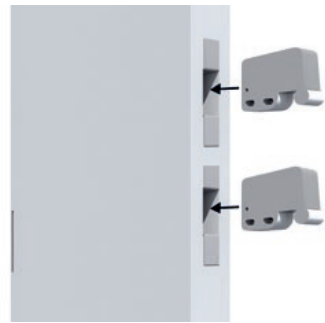

E



17



4x

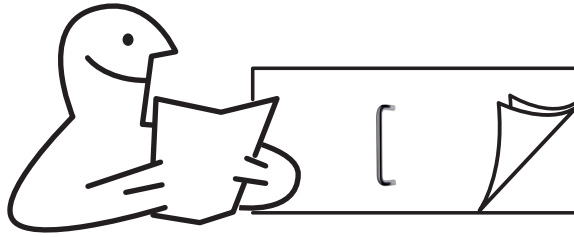

B

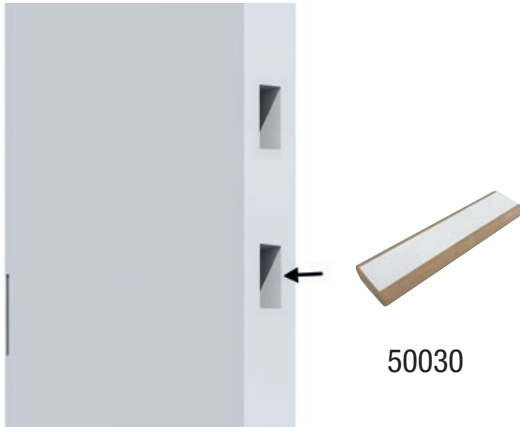

18



19



1x



2x



2x

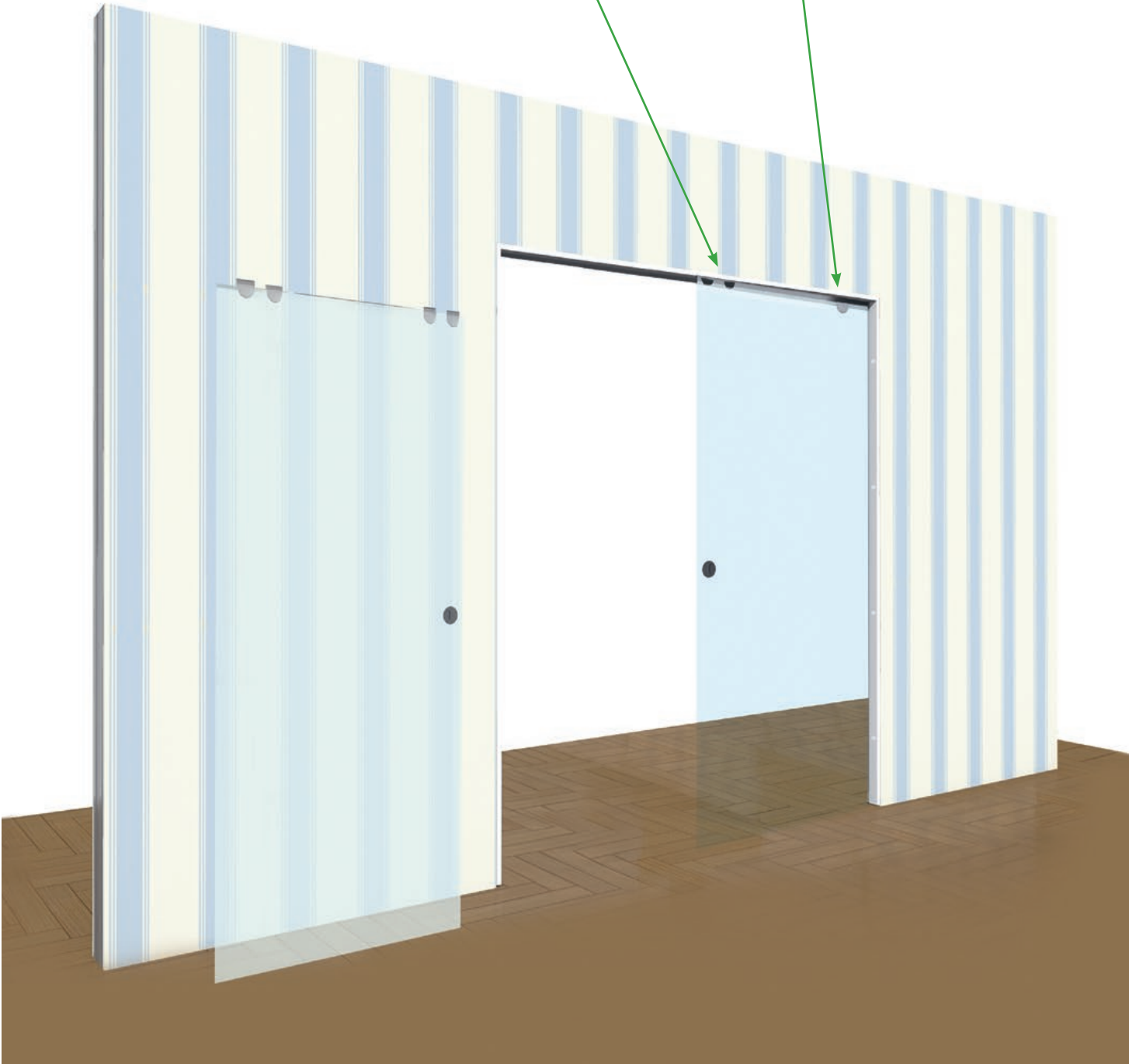

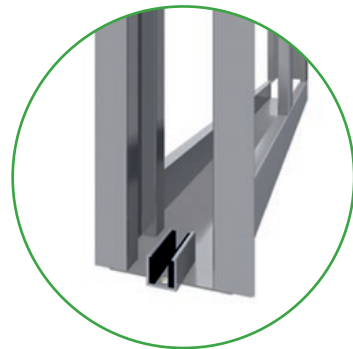
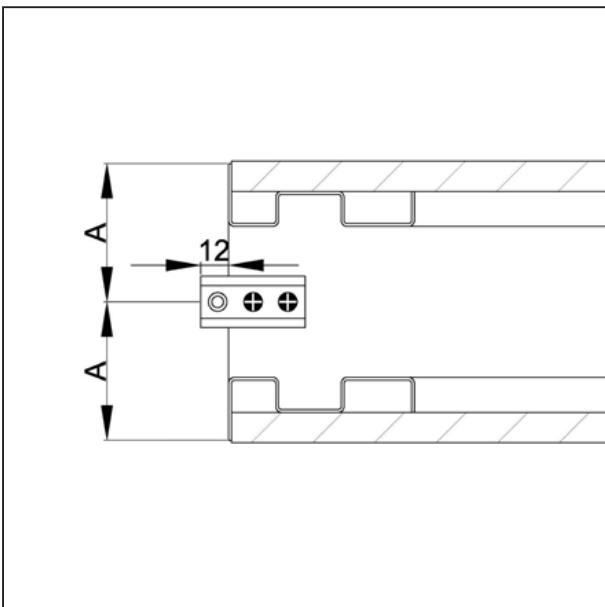
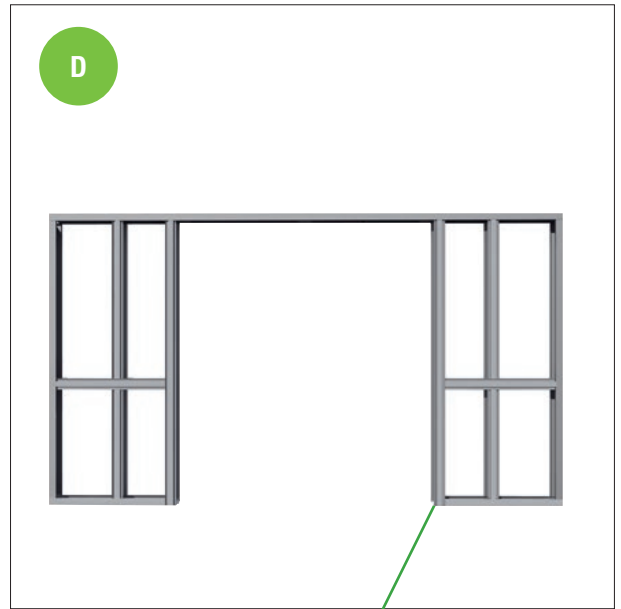
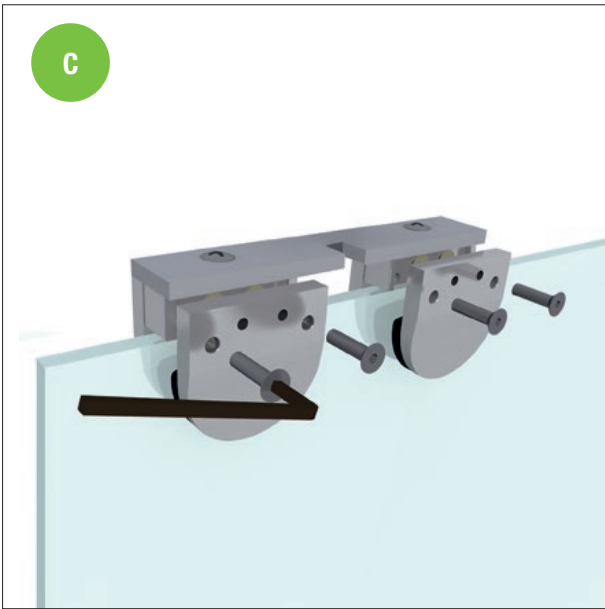

20

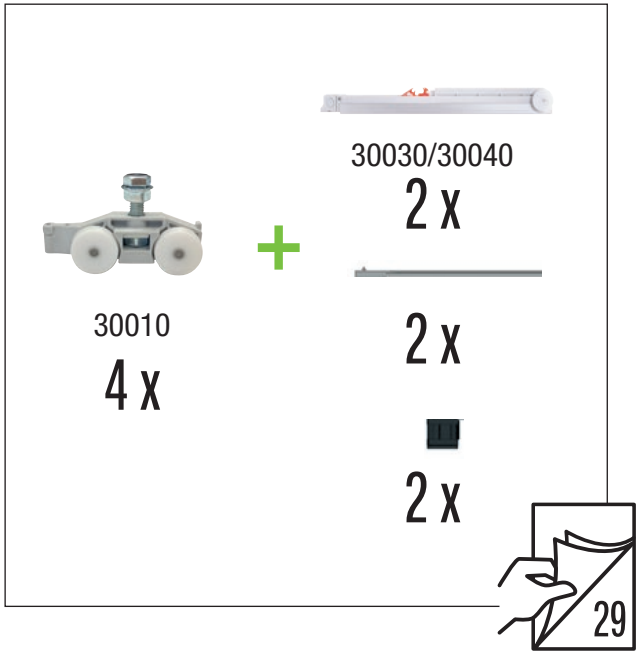
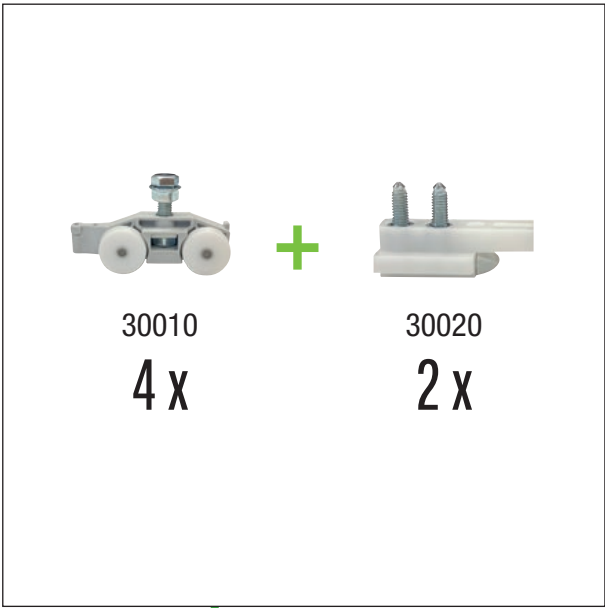

21



30010

4 x



30030

2 x



30040

2 x

A

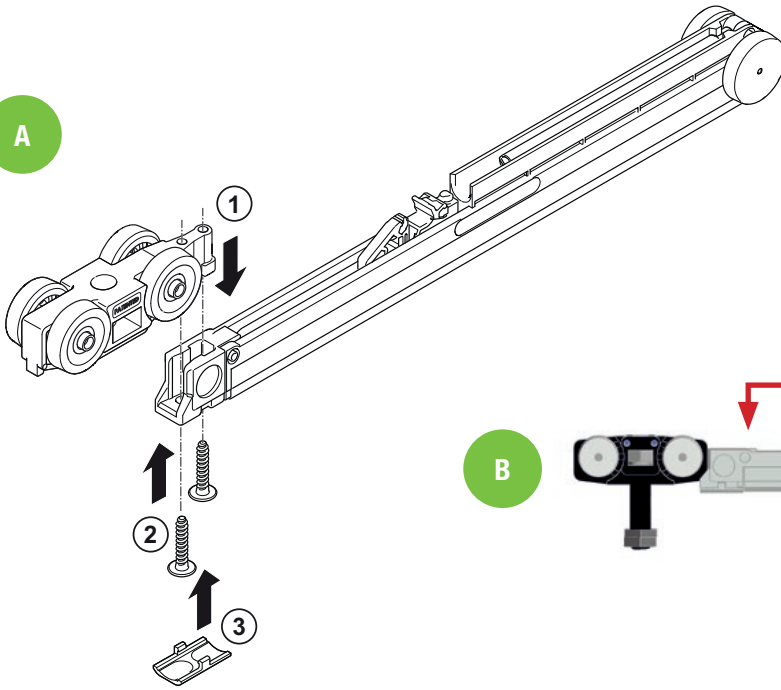

B

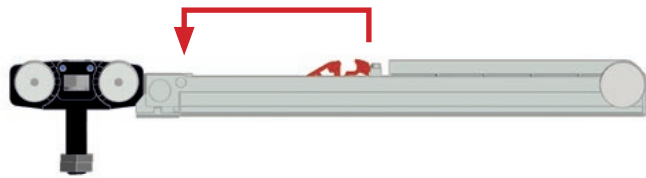

22



24

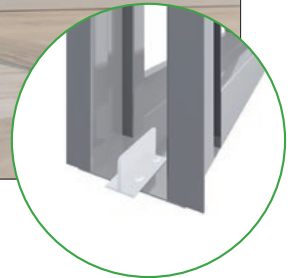
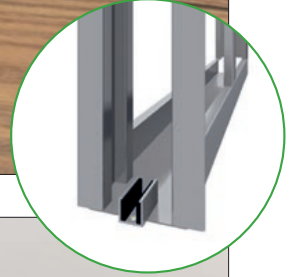
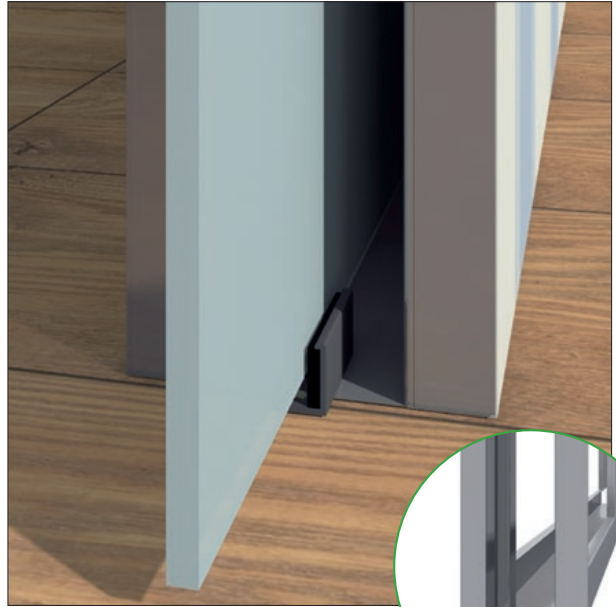

25



40010

1x

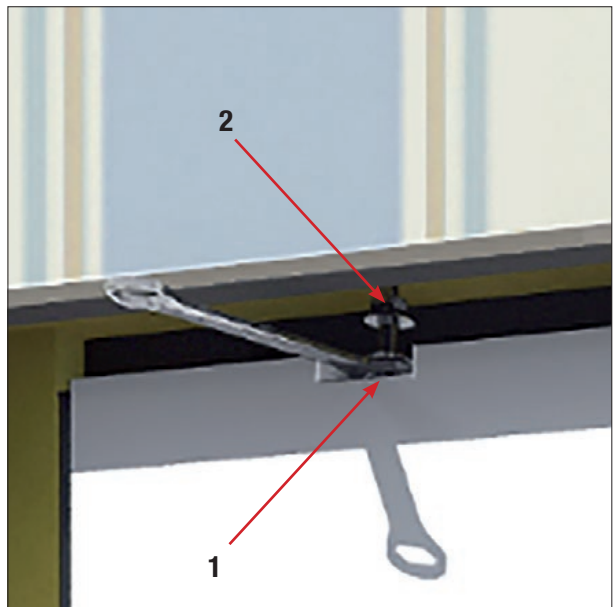

26

A



10030

25 x



20010

25 x

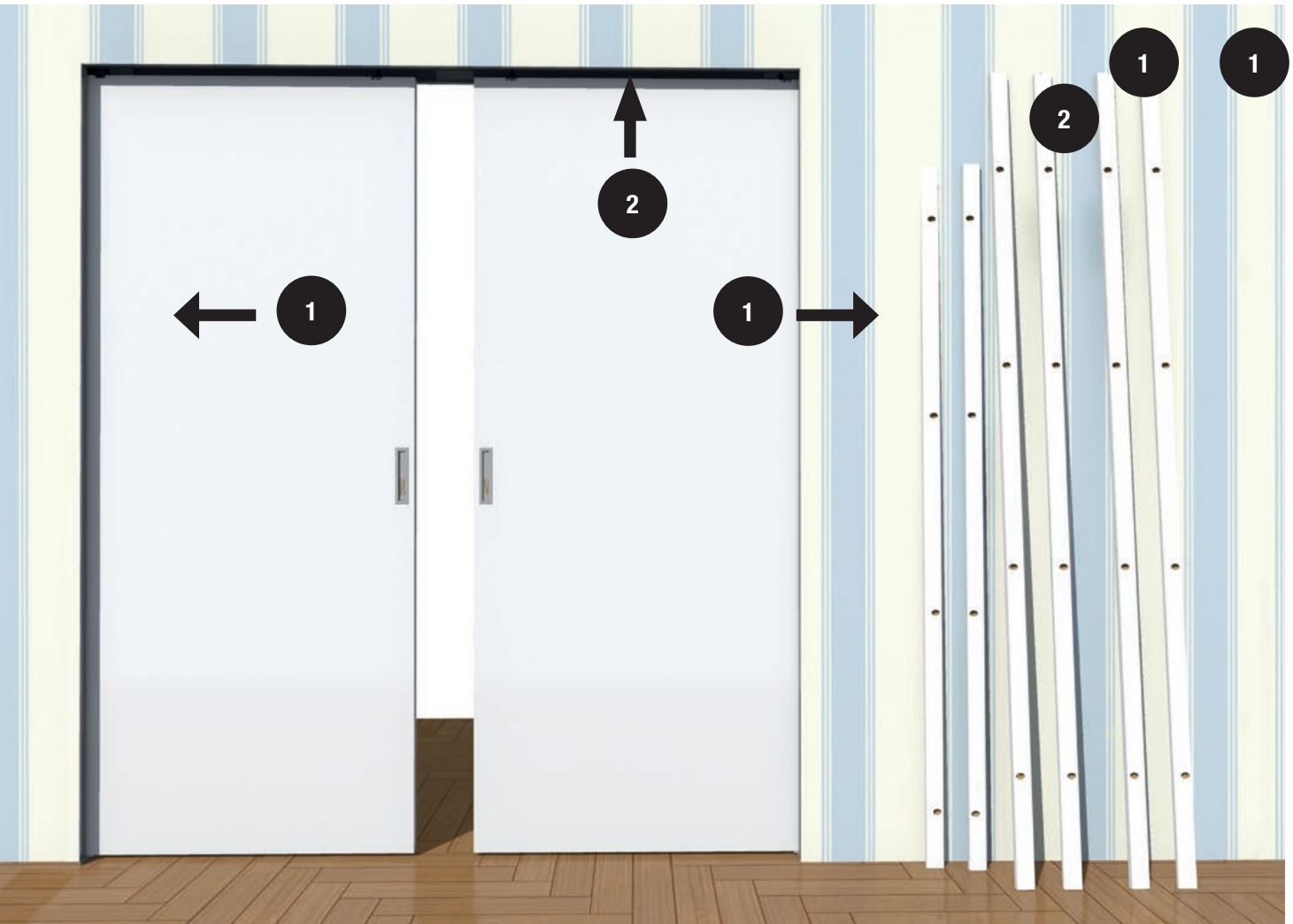

27



40030

1x

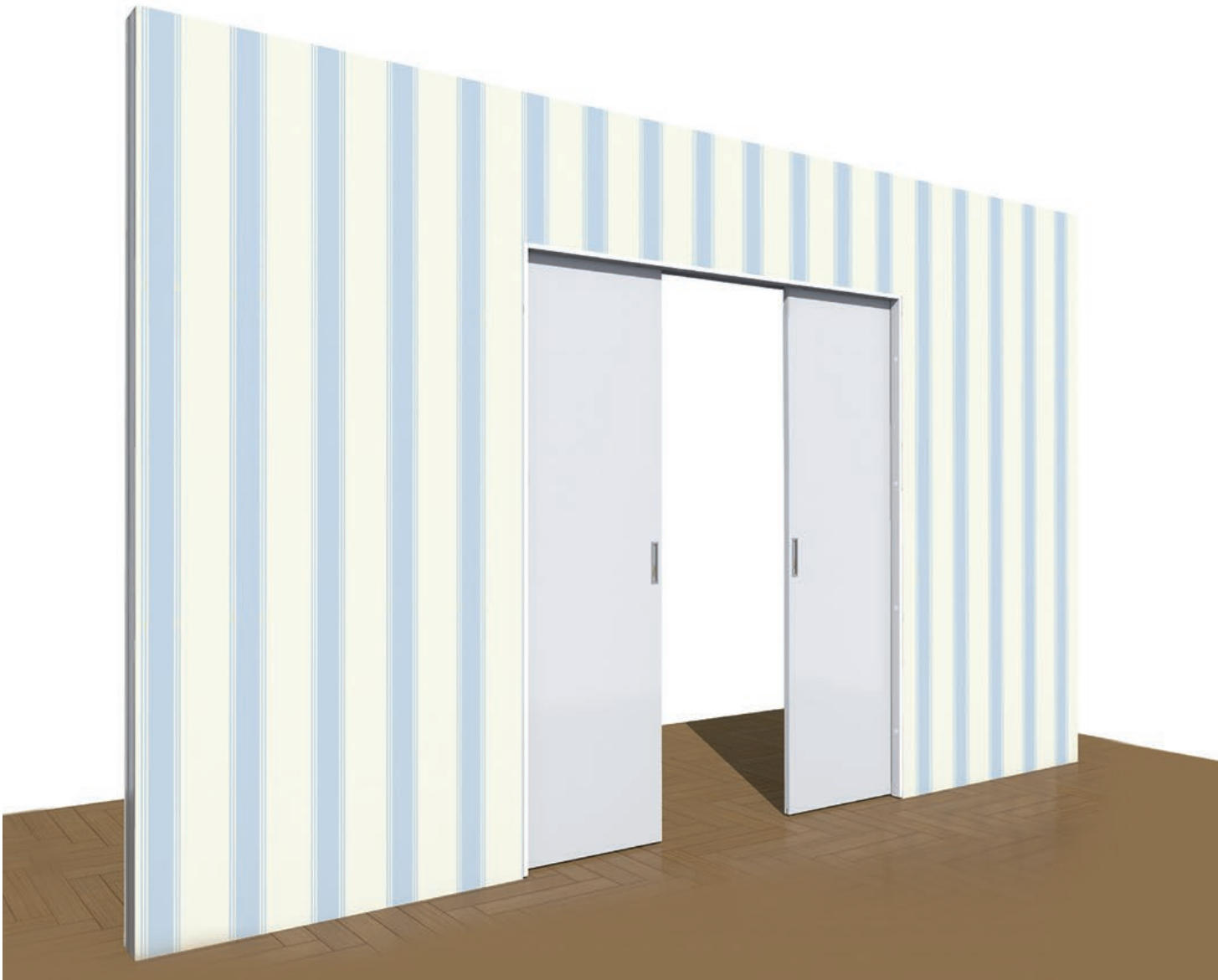



Liune Door Sales Office:
Aulis Lundell Oy
www.liunedoor.com

LIUNE
NORDIC
DESIGN



EPD No. RTS_38_19
LIUNE -door system
with glass/MDF door



Aulis Lundell Oy's production is certified by
the ISO9001 –quality management system.
The certification has been witheld since 2004.



Business environmentally certified since 2004.
Liune Door is patented.



**OHJEESSA OLEVIEN KUVIEN LAINAAMINEN ON SALLITTUA VAIN
AULIS LUNDELL OY:N ASIAKKAILLE JA YHTEISTYÖKUMPPANEILLE,
KUN LÄHDE MAINITAAN. KUVIIN JA NIIHIN LIITTYVIIN TEKSTEIHIN PIDÄTÄMME
OIKEUDEN TEHDÄ MUUTOKSIA.**

**ATT LÅNA BILDERNA I DENNA INSTRUKTION ÄR TILLÅTET ENDAST FÖR
AULIS LUNDELL OY:S KUNDER OCH SAMARBETSPARTNERS OM KÄLLAN NÄMNS.
VI FÖRBEHÅLLER OSS RÄTTEN ATT GÖRA ÄNDRINGAR PÅ BILDERNA OCH DE
TILLHÖRANDE TEXTERNA.**

**TO BORROW THE PICTURES IN THIS INSTRUCTION MANUAL IS ALLOWED TO
AULIS LUNDELL OY'S CUSTOMERS AND PARTNERS IF THE SOURCE IS MENTIONED.
WE RESERVE THE RIGHT TO MAKE CHANGES TO THE PICTURES AND
THE ACCOMPANING TEXTS.**

**HET GEBRUIK VAN DE AFBEELDINGEN UIT DEZE MONTAGE INSTRUCTIE IS TOEGESTAAN
VOOR KLANTEN EN PARTNERS VAN AULIS LUNDELL OY ONDER VERMELDING VAN DE BRON.
WIJ BEHOUDEN ONS HET RECHT VOOR OM VERANDERINGEN AAN TE BRENGEN IN DE
AFBEELDINGEN EN DE BEGELEIDENDE TEKST.**

